

2 RoK 62,3 Kvm + Uteplats 30 Kvm

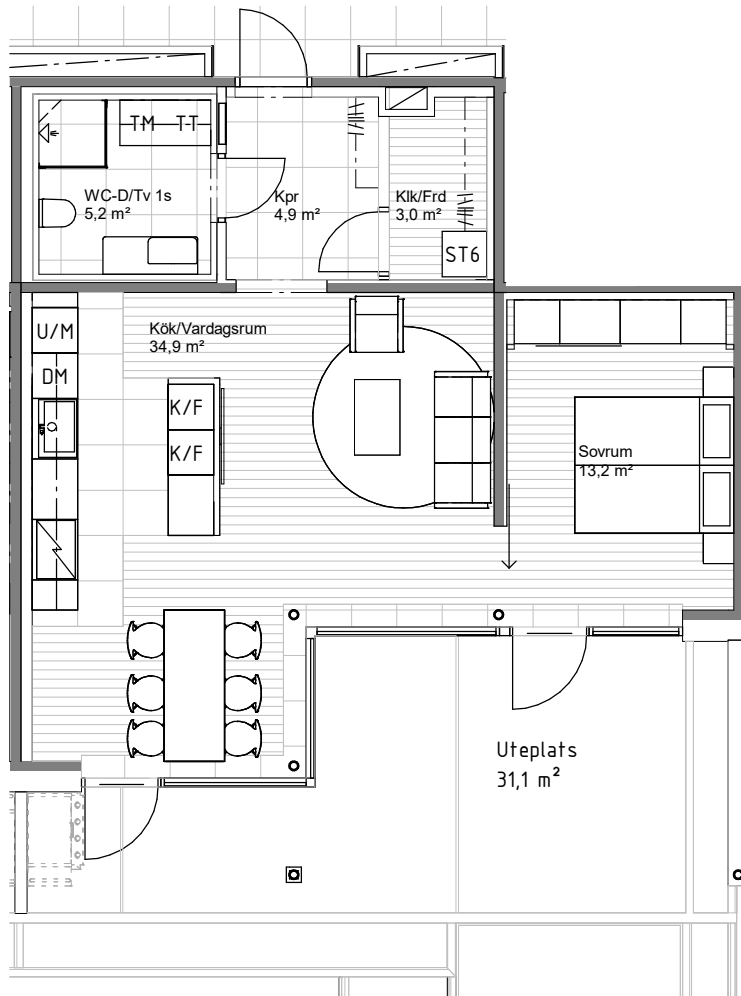

SKALA 1:100

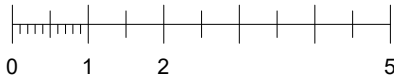

METER

PROJEKTUTVEKLAREN RESERVERAR SIG FÖR
EVENTUELLA ÄNDRINGAR OCH TRYCKFEL

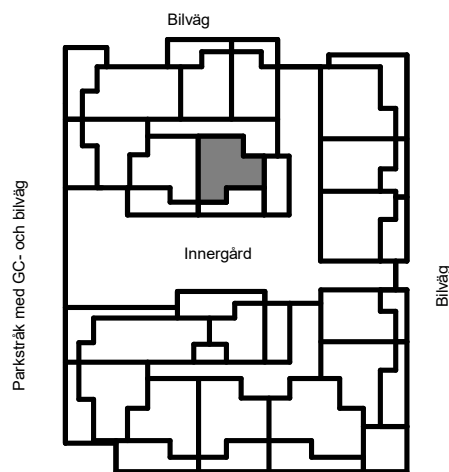

ÖVERSIKTSPLAN, PLACERING LGH (1:1000)

Kv 2, Råbylund, Lund

LGH NR:

11001

JOHAN SENNSTRÖM ARK SAR/MSA

2021-09-03, Rev.2023-12-05

2 RoK 63,3 Kvm + Uteplats 38 Kvm

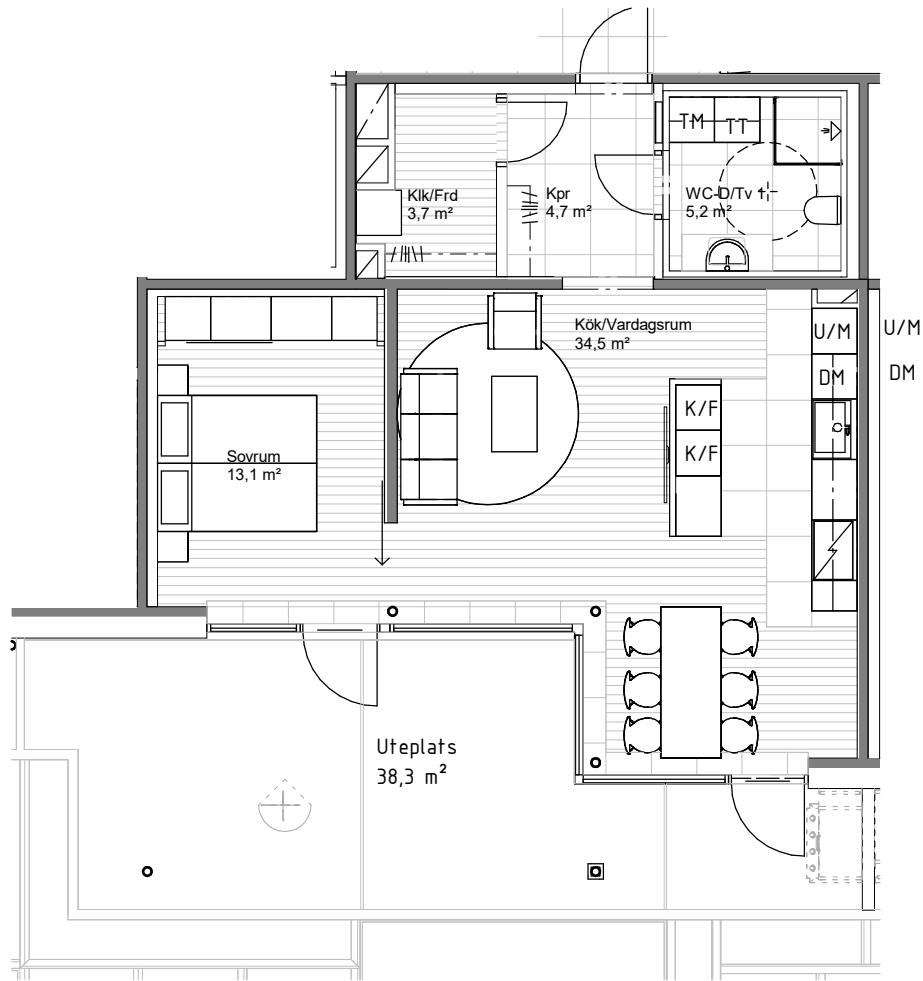

SKALA 1:100

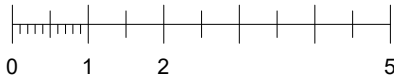

METER

PROJEKTUTVEKLAREN RESERVERAR SIG FÖR
EVENTUELLA ÄNDRINGAR OCH TRYCKFEL

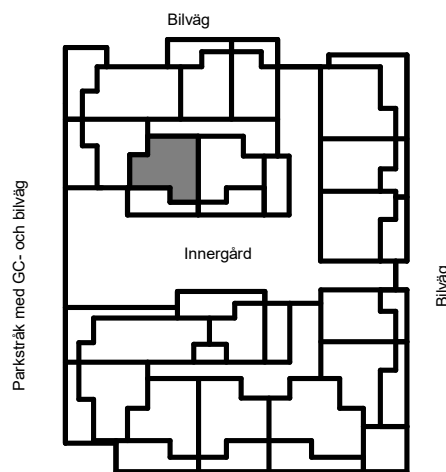

ÖVERSIKTSPLAN, PLACERING LGH (1:1000)

Kv 2, Råbylund, Lund

LGH NR:

11002

JOHAN SENNSTRÖM ARK SAR/MSA

2021-09-03, Rev.2023-12-05

2 Rok 58,4 Kv m + Uteplats 37 Kv m + externt frd 3,9 Kv m

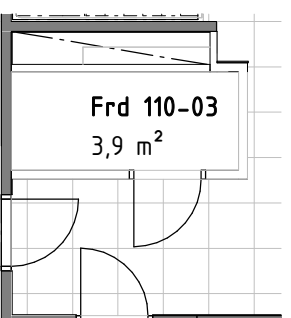

Extern Förråd ligger på Plan 12 i samma trapphus som lägenheten

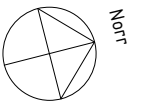

SKALA 1:100

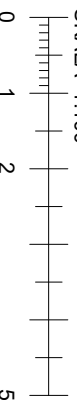

Parkstråk med GC- och bilväg

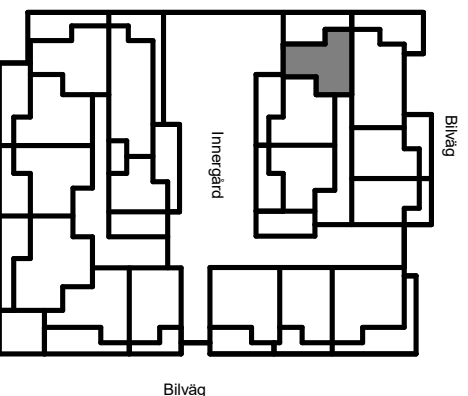

ÖVERSIKTSPLAN, PLACERING LGH (1:1000)

Kv 2, Råbylund, Lund

LGH NR:

11003

JOHAN SENNSTRÖM ARK SARMISA

2021-09-03, Rev.2024-05-26

3 Rok 83,2 Kv m + Uteplats 33 Kv m + 6 Kv m ext. förråd i källaren

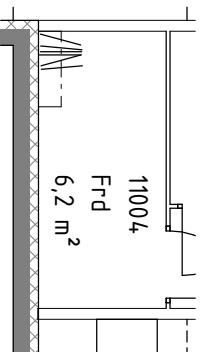
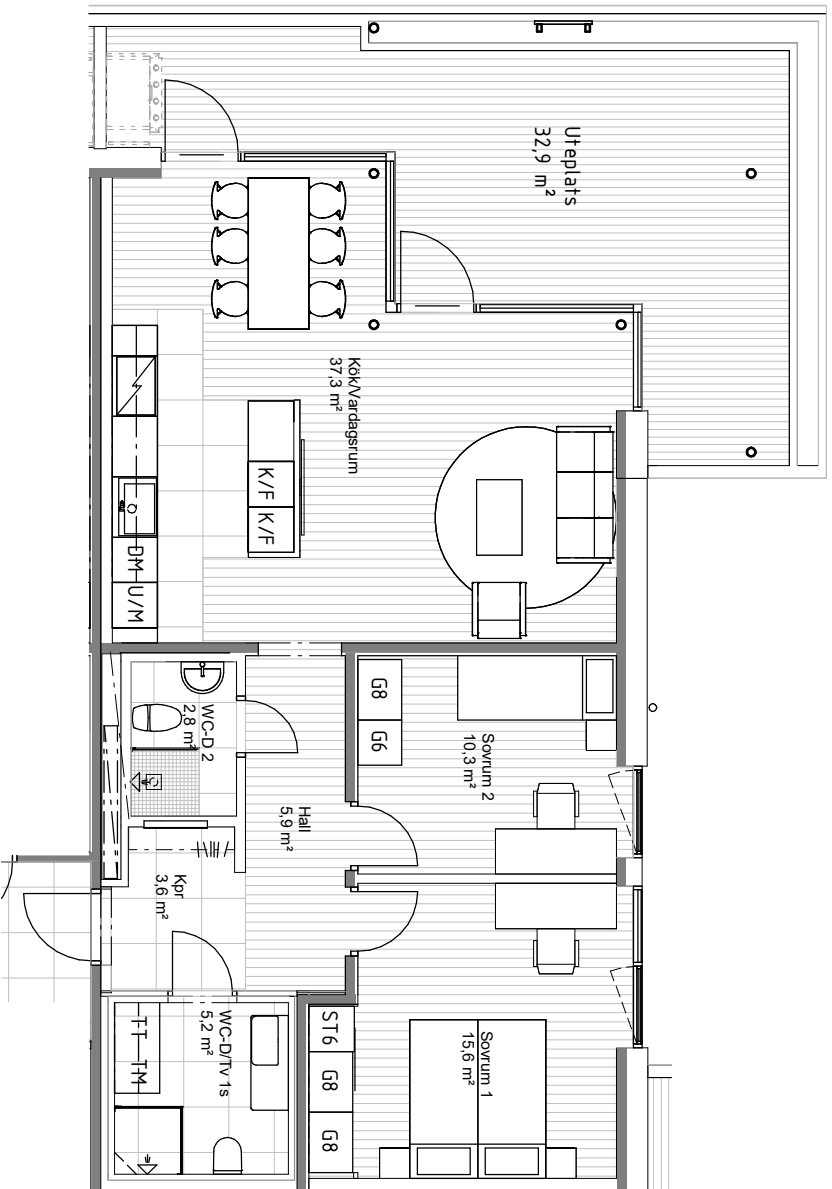

11004 Fråd i Källare

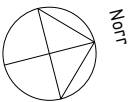

SKALA 1:100

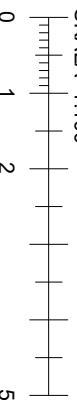

METER

Parkstråk med GC- och bilväg

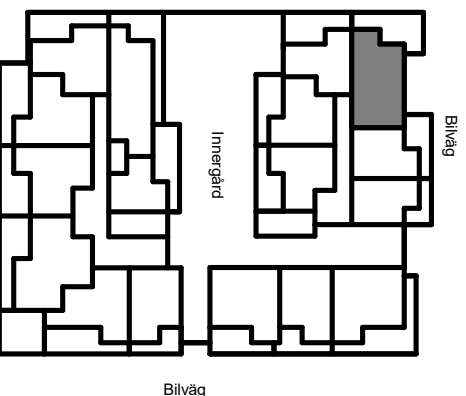

ÖVERSIKTSPLAN, PLACERING LGH (1:1000)

Kv 2, Råbylund, Lund
LGH NR:
11004

JOHAN SENNSTRÖM ARK SARIMSA
2021-09-03, Rev.2024-05-26

2 RoK 52.7 Kvm + Uteplats 20 Kvm

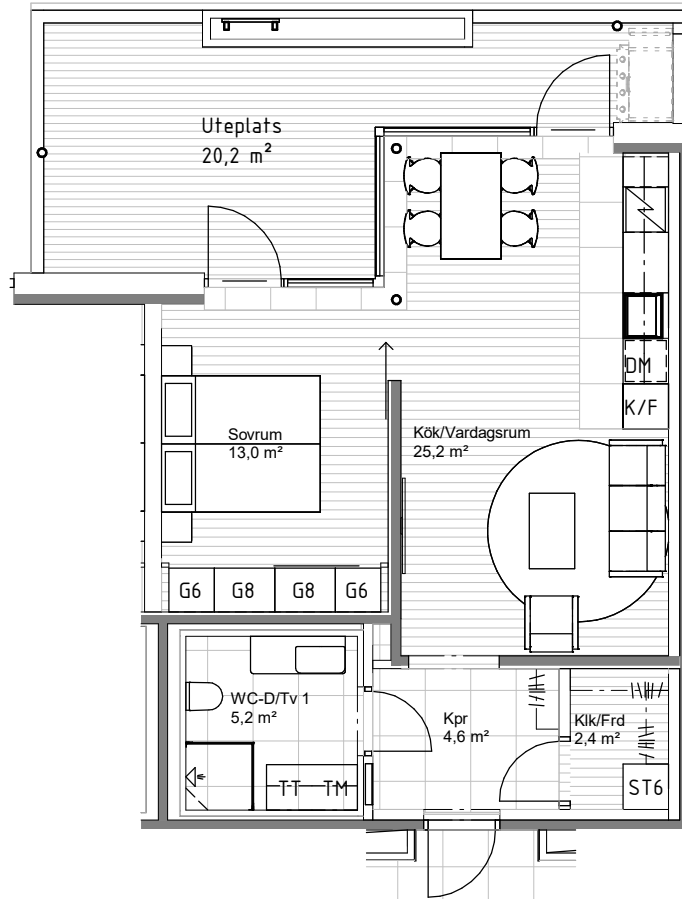

SKALA 1:100

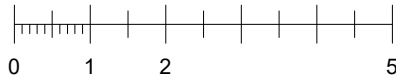

METER

PROJEKTUTVEKLAREN RESERVERAR SIG FÖR
EVENTUELLA ÄNDRINGAR OCH TRYCKFEL

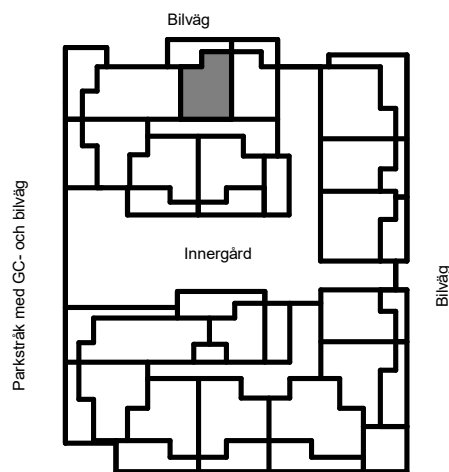

ÖVERSIKTSPLAN, PLACERING LGH (1:1000)

Kv 2, Råbylund, Lund

LGH NR:

11005

JOHAN SENNSTRÖM ARK SAR/MSA

2021-09-03, Rev.2023-12-05

2 RoK 52,6 Kvm + Uteplats 15 Kvm

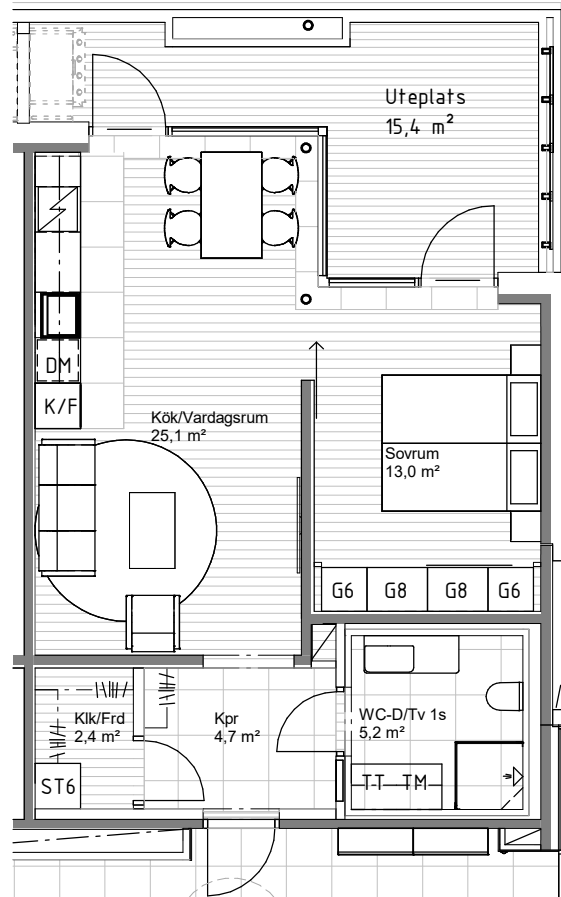

SKALA 1:100

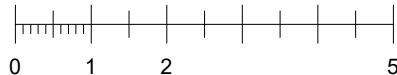

METER

PROJEKTUTVEKLAREN RESERVERAR SIG FÖR
EVENTUELLA ÄNDRINGAR OCH TRYCKFEL

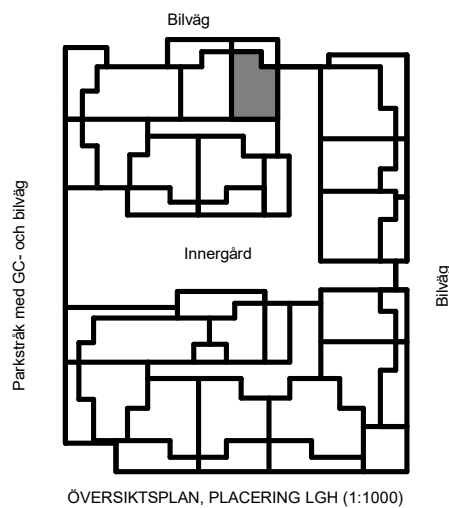

Kv 2, Råbylund, Lund

LGH NR:

11006

JOHAN SENNSTRÖM ARK SAR/MSA

2021-09-03, Rev.2023-12-05

3 Rok 79,6 Kv_m + Uteplats 4,1 Kv_m

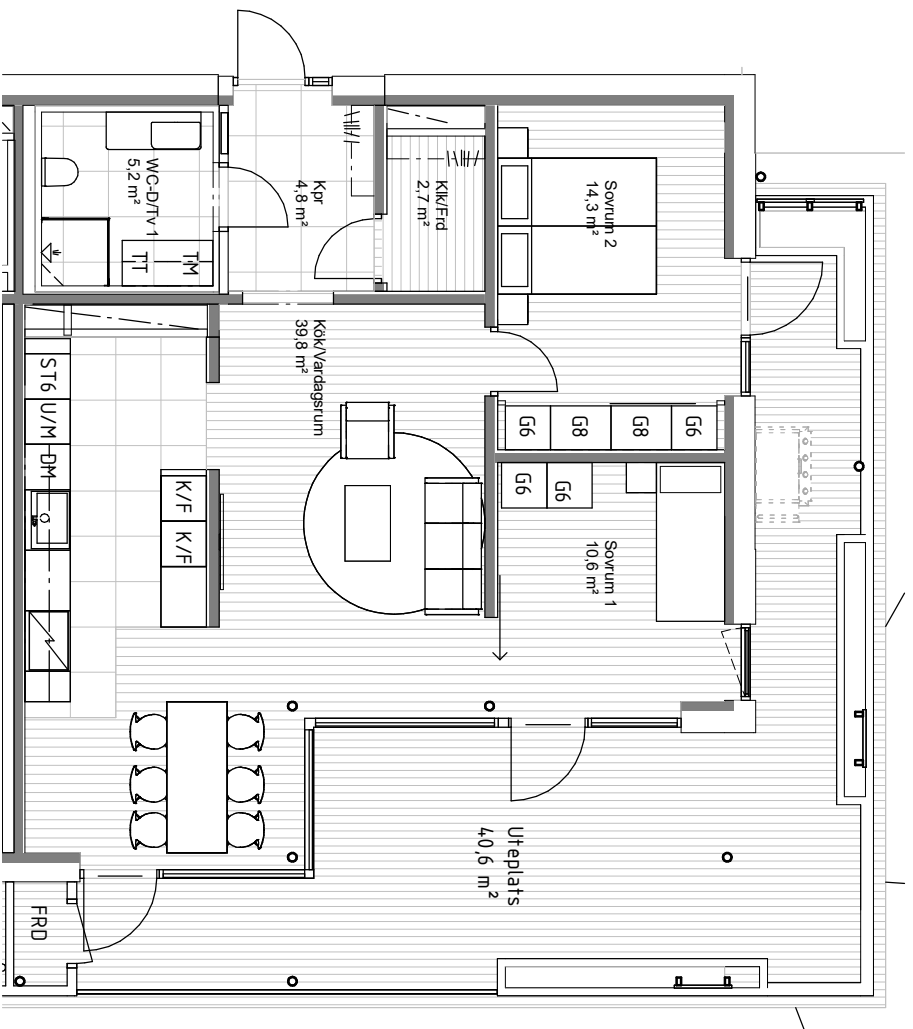

SKALA 1:100

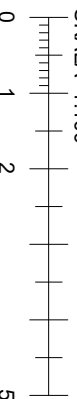

METER

Parkstråk med GC- och bilväg

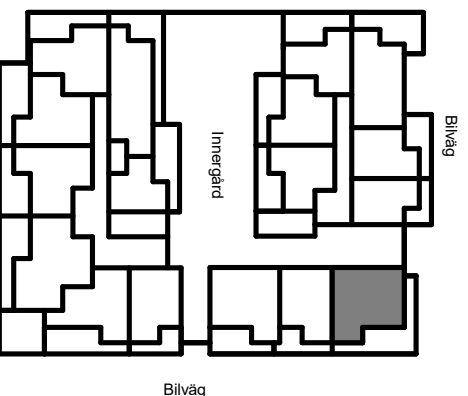

ÖVERSIKTSPLAN, PLACERING LGH (1:1000)

Bilväg

Innergård

Kv 2, Råbylund, Lund

LGH NR:

11007

JOHAN SENNSTRÖM ARK SARMSA

2021-09-03, Rev.2024-05-26

2 Rok 55,0 Kv m + 3,1 Kv m frd + Uteplats 16 Kv m

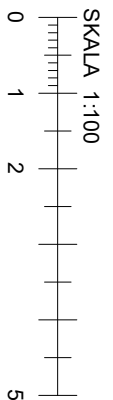

Parkstråk med GC- och bilväg

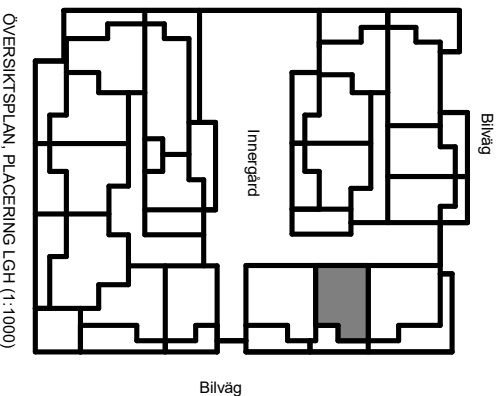

ÖVERSIKTSPLAN, PLACERING LGH (1:1000)

Kv 2, Råbylund, Lund
LGH NR:
11008

JOHAN SENNSTRÖM ARK SARMSA
2021-09-03, Rev.2024-05-26

PROJEKTUTVEKLAREN RESERVERAR SIG FÖR
EVENTUELLA ÄNDRINGAR OCH TRYCKFEL

3 RoK 80,9 Kvm + Uteplats 25 Kvm

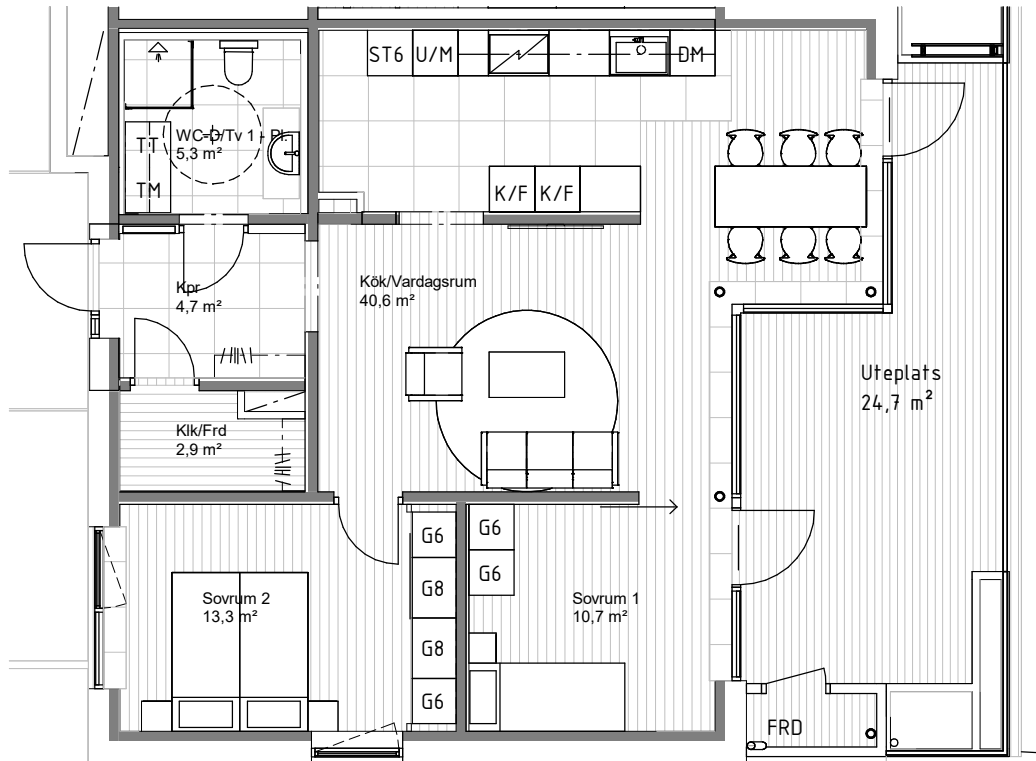

SKALA 1:100

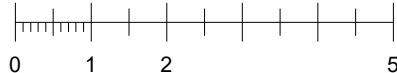

METER

PROJEKTUTVECKLAREN RESERVERAR SIG FÖR
EVENTUELLA ÄNDRINGAR OCH TRYCKFEL

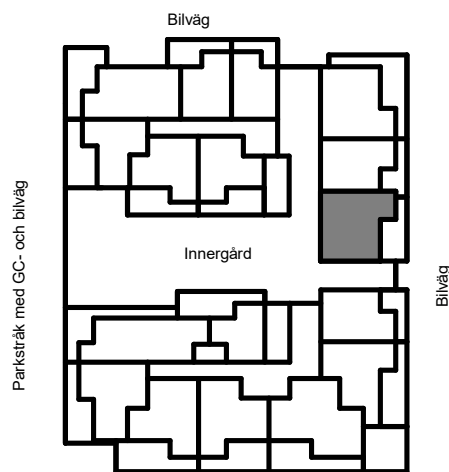

ÖVERSIKTSPLAN, PLACERING LGH (1:1000)

Kv 2, Råbylund, Lund

LGH NR:

11009

JOHAN SENNSTRÖM ARK SAR/MSA

2021-09-03, Rev.2023-12-05

2 RoK 63,0 Kvm + Uteplats 23 Kvm

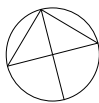
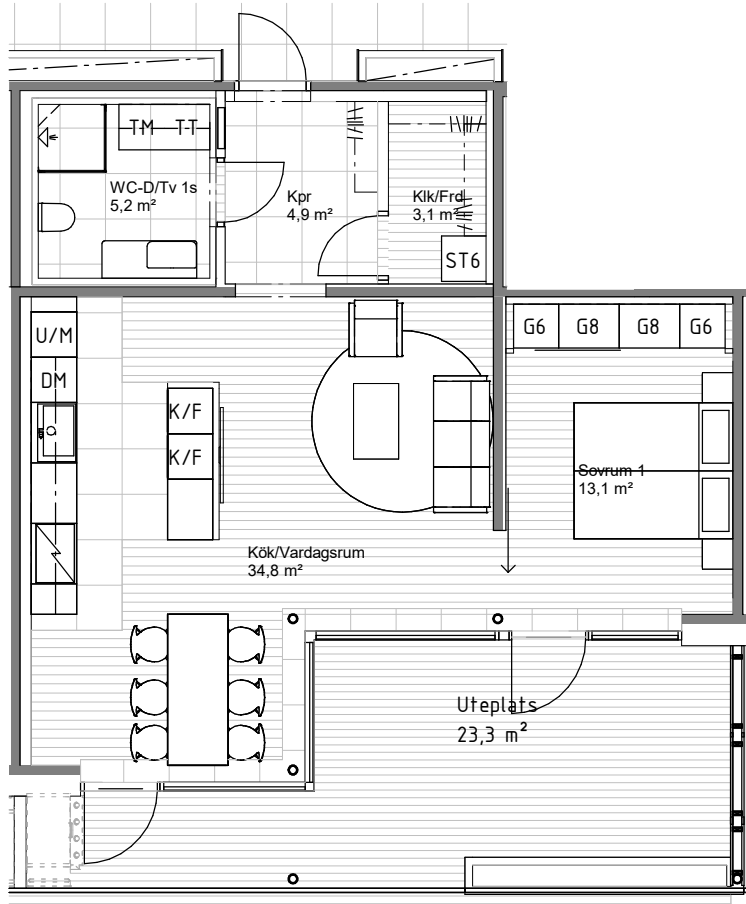

SKALA 1:100

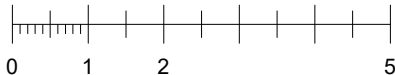

METER

PROJEKTUTVEKLAREN RESERVERAR SIG FÖR
EVENTUELLA ÄNDRINGAR OCH TRYCKFEL

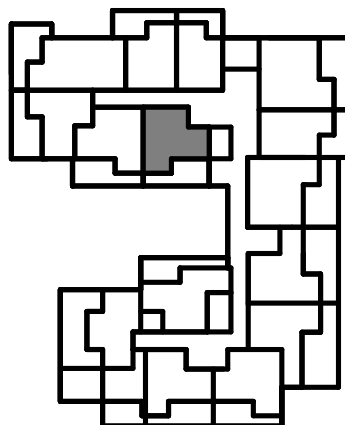

Kv 2, Råbylund, Lund

LGH NR:

11101

JOHAN SENNSTRÖM ARK SAR/MSA

2021-09-03, Rev.2023-12-05

4 RoK 121,4 Kvm + Uteplats 53 Kvm

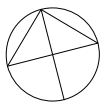
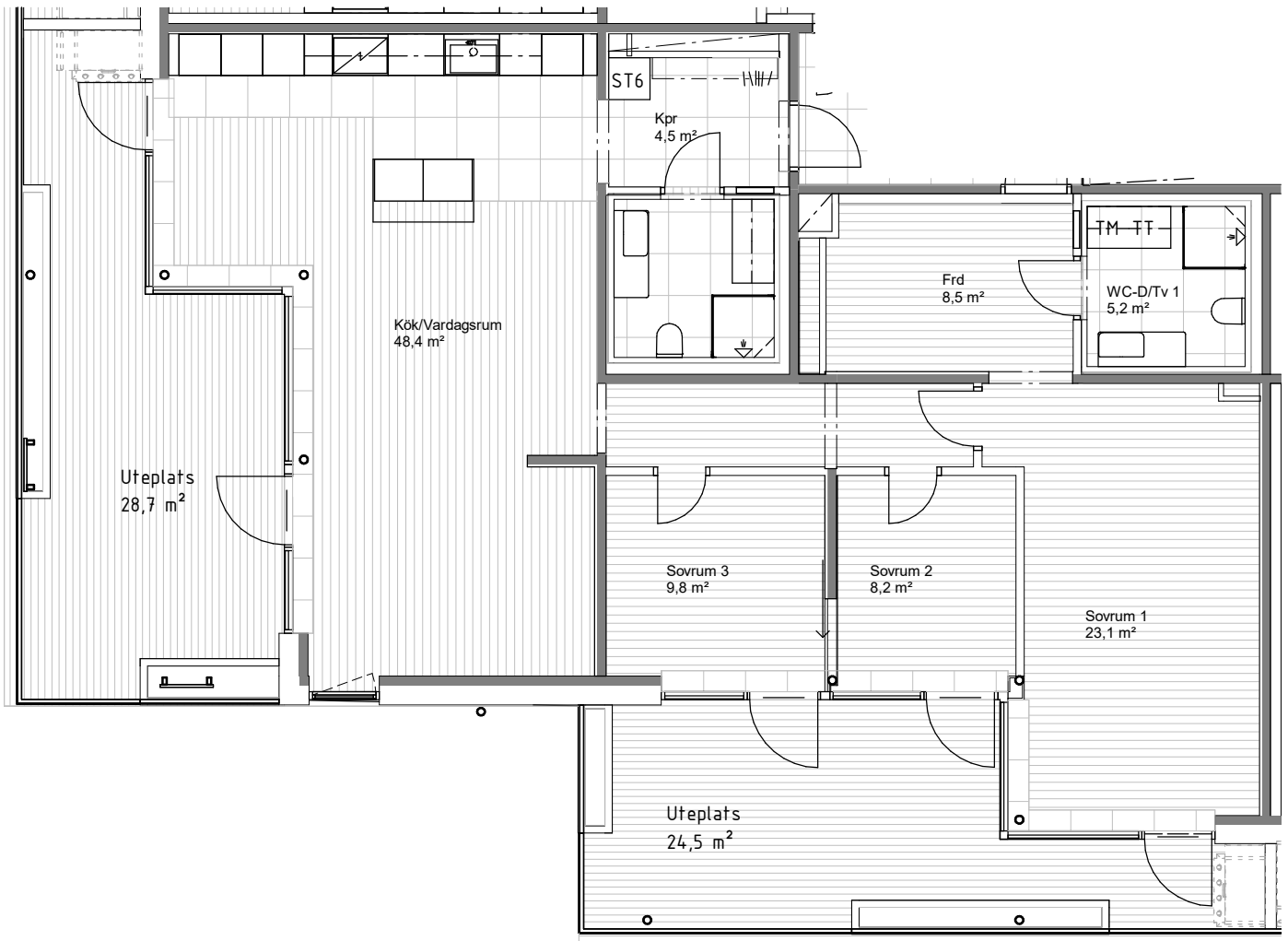

SKALA 1:100

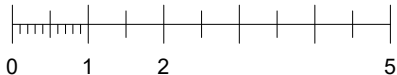

METER

PROJEKTUTVEKLAREN RESERVERAR SIG FÖR
EVENTUELLA ÄNDRINGAR OCH TRYCKFEL

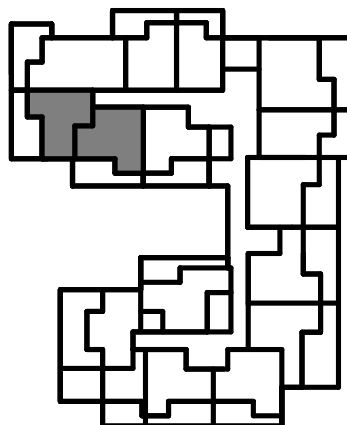

Kv 2, Råbylund, Lund

LGH NR:

11102 o 11103

JOHAN SENNSTRÖM ARK SAR/MSA

2021-09-03, Rev.2023-12-05

3 RoK 82,6 Kvm + Uteplats 28 Kvm + 5,4 Kvm externt förråd i källaren

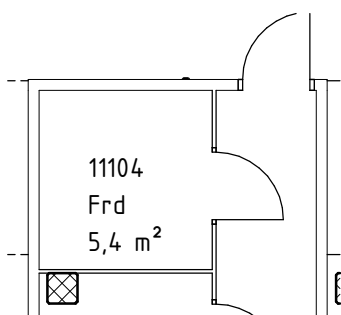
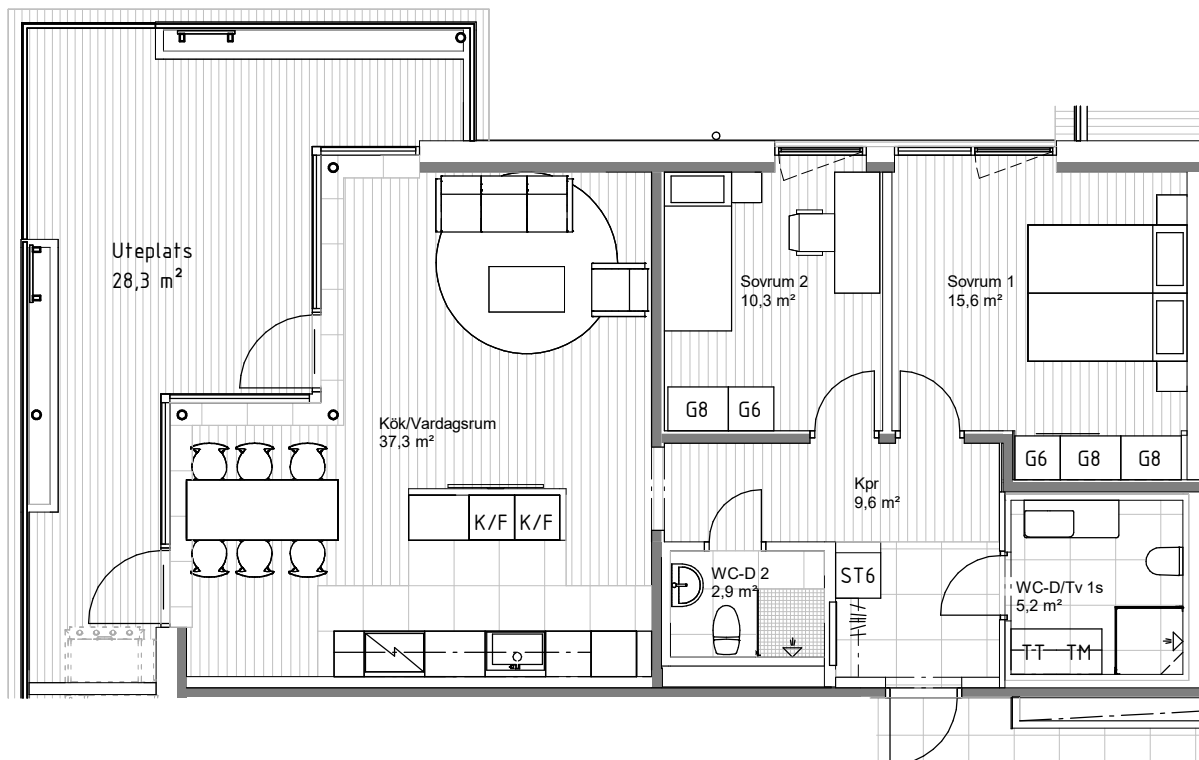

11104 Frd

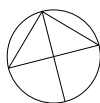

SKALA 1:100

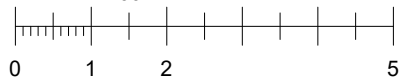

METER

PROJEKTUTVEKLAREN RESERVERAR SIG FÖR
EVENTUELLA ÄNDRINGAR OCH TRYCKFEL

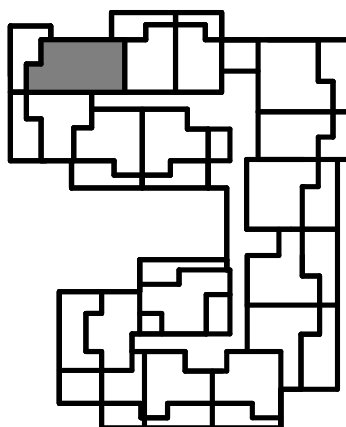

Kv 2, Råbylund, Lund

LGH NR:

11104

JOHAN SENNSTRÖM ARK SAR/MSA

2021-09-03, Rev.2023-12-05

2 RoK 52,7 Kvm + Uteplats 21 Kvm

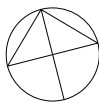
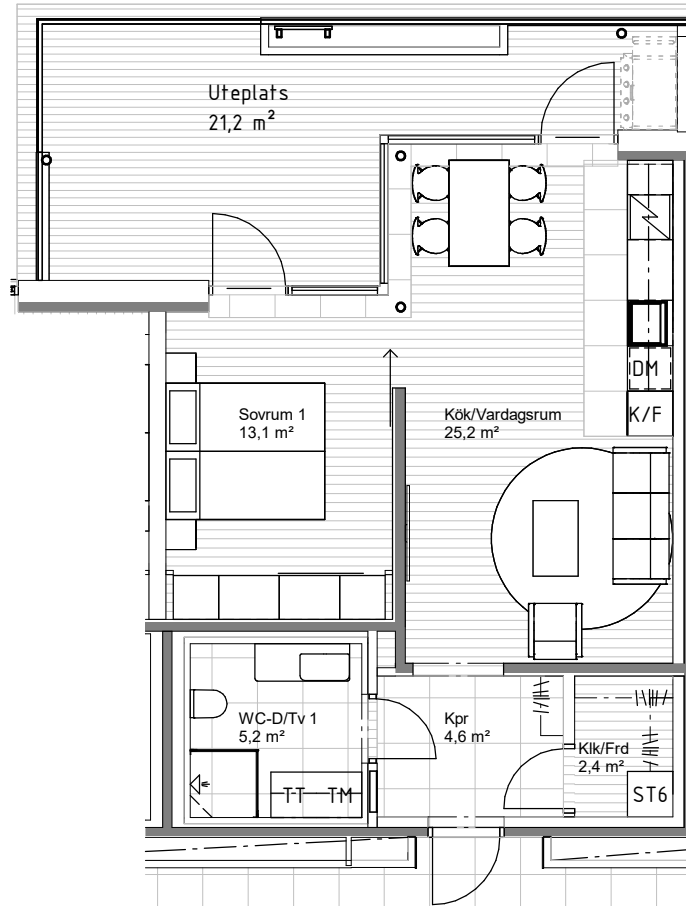

SKALA 1:100

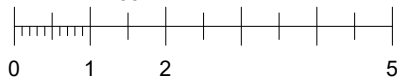

METER

PROJEKTUTVEKLAREN RESERVERAR SIG FÖR
EVENTUELLA ÄNDRINGAR OCH TRYCKFEL

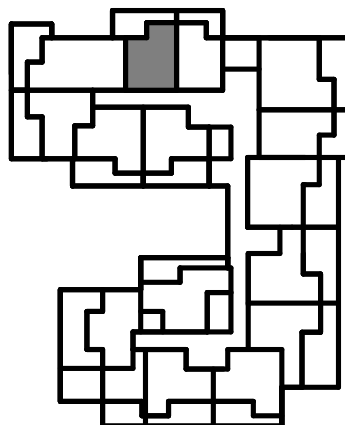

Kv 2, Råbylund, Lund

LGH NR:

11105

JOHAN SENNSTRÖM ARK SAR/MSA

2021-09-03, Rev.2023-12-05

2 RoK 52,6 Kvm + Uteplats 16 Kvm

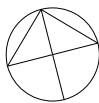
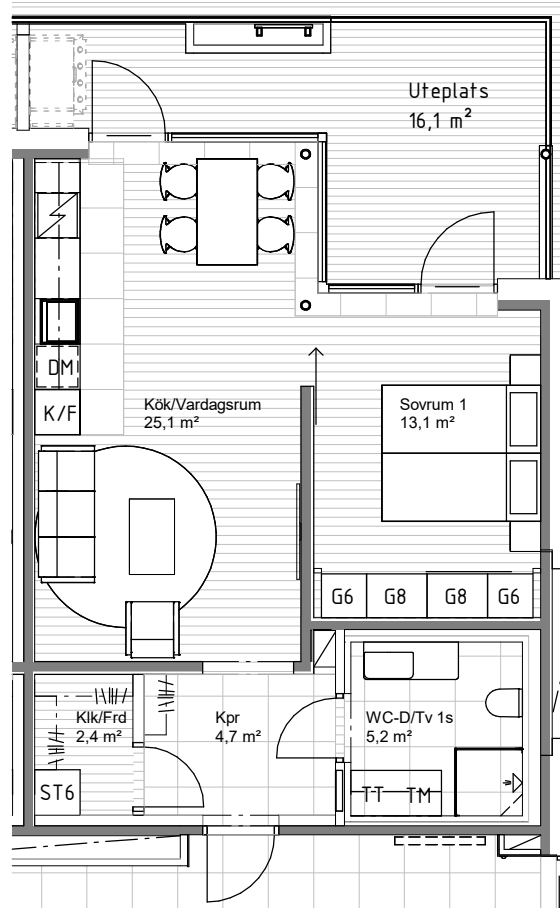

SKALA 1:100

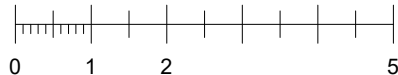

METER

PROJEKTUTVEKLAREN RESERVERAR SIG FÖR
EVENTUELLA ÄNDRINGAR OCH TRYCKFEL

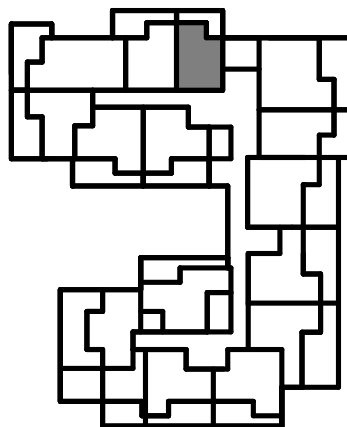

Kv 2, Råbylund, Lund

LGH NR:

11106

JOHAN SENNSTRÖM ARK SAR/MSA

2021-09-03, Rev.2023-12-05

3 RoK 78,9 Kvm + Uteplats 42 Kvm

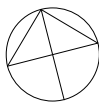
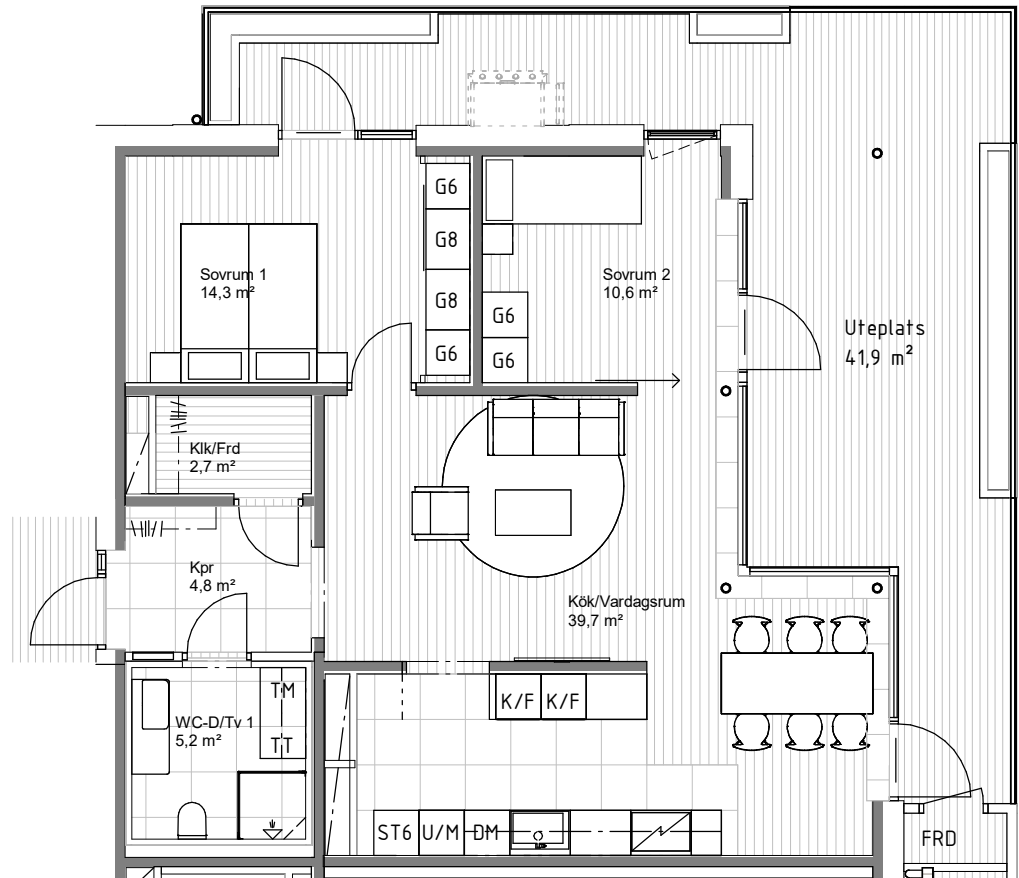

SKALA 1:100

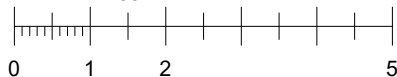

METER

PROJEKTUTVEKLAREN RESERVERAR SIG FÖR
EVENTUELLA ÄNDRINGAR OCH TRYCKFEL

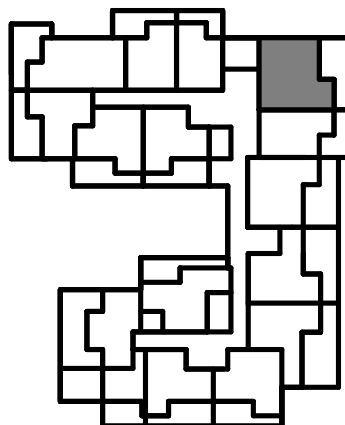

Kv 2, Råbylund, Lund

LGH NR:

11107

JOHAN SENNSTRÖM ARK SAR/MSA

2021-09-03, Rev.2023-12-05

2 RoK 55,0 Kvm + Frd 3,5 Kvm + Uteplats 18 Kvm

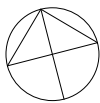
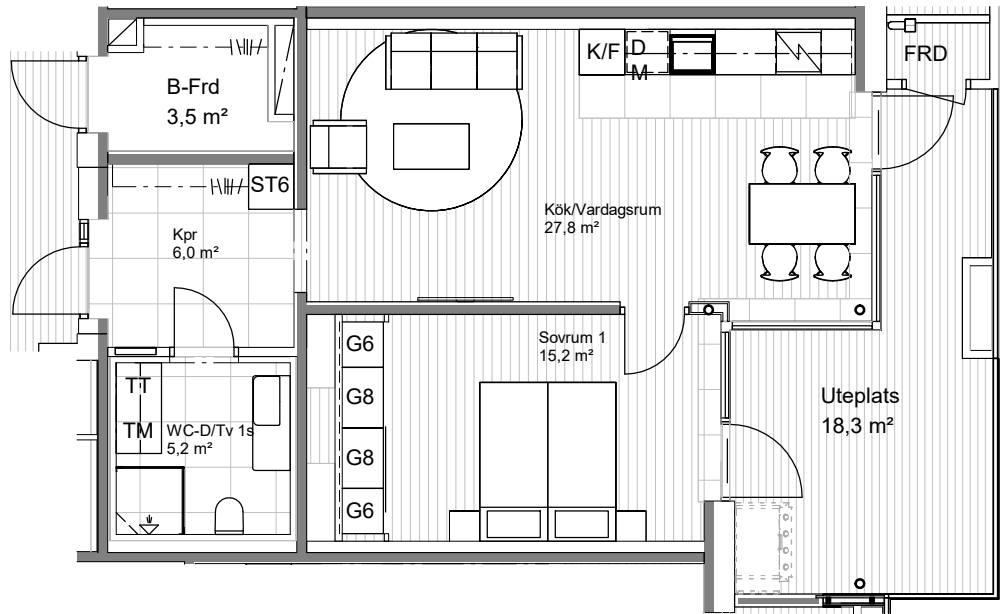

SKALA 1:100

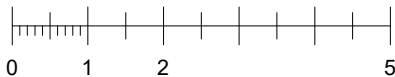

METER

PROJEKTUTVECKLAREN RESERVERAR
SIG FÖR EVENTUELLA ÄNDRINGAR OCH
TRYCKFEL

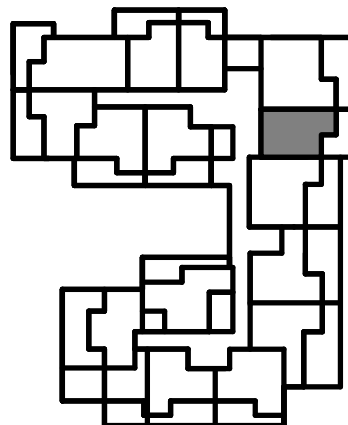

Kv 2, Råbylund, Lund

LGH NR:

11108

JOHAN SENNSTRÖM ARK SAR/MSA

2021-09-03, Rev.2024-07-03

3 RoK 76,0 Kvm + Uteplats 30 Kvm

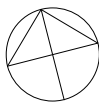
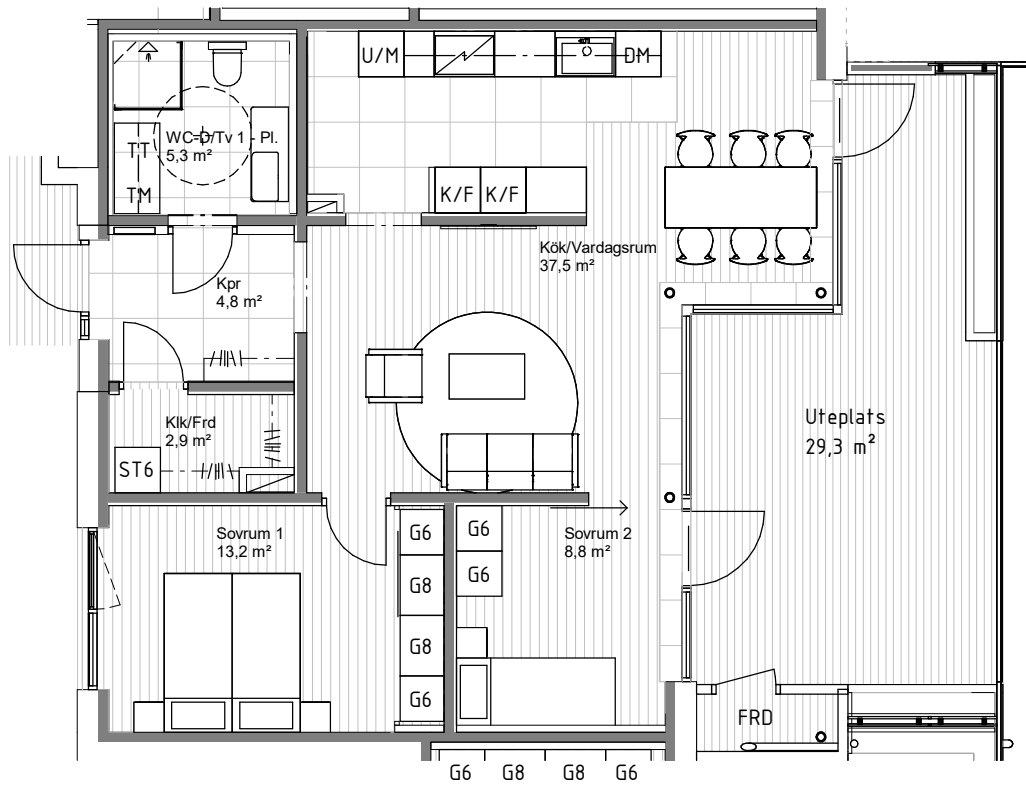

SKALA 1:100



METER

PROJEKTUTVEKLAREN RESERVERAR SIG FÖR
EVENTUELLA ÄNDRINGAR OCH TRYCKFEL

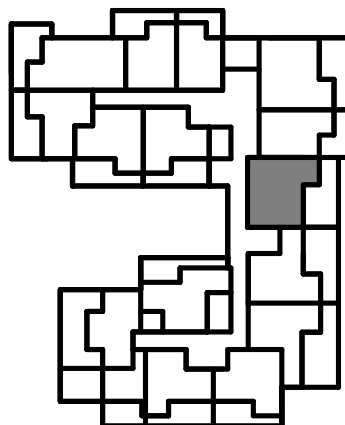

Kv 2, Råbylund, Lund

LGH NR:

11109

JOHAN SENNSTRÖM ARK SAR/MSA

2021-09-03, Rev.2023-12-05

2 RoK 63,0 Kvm + Uteplats 23 Kvm

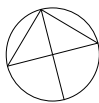
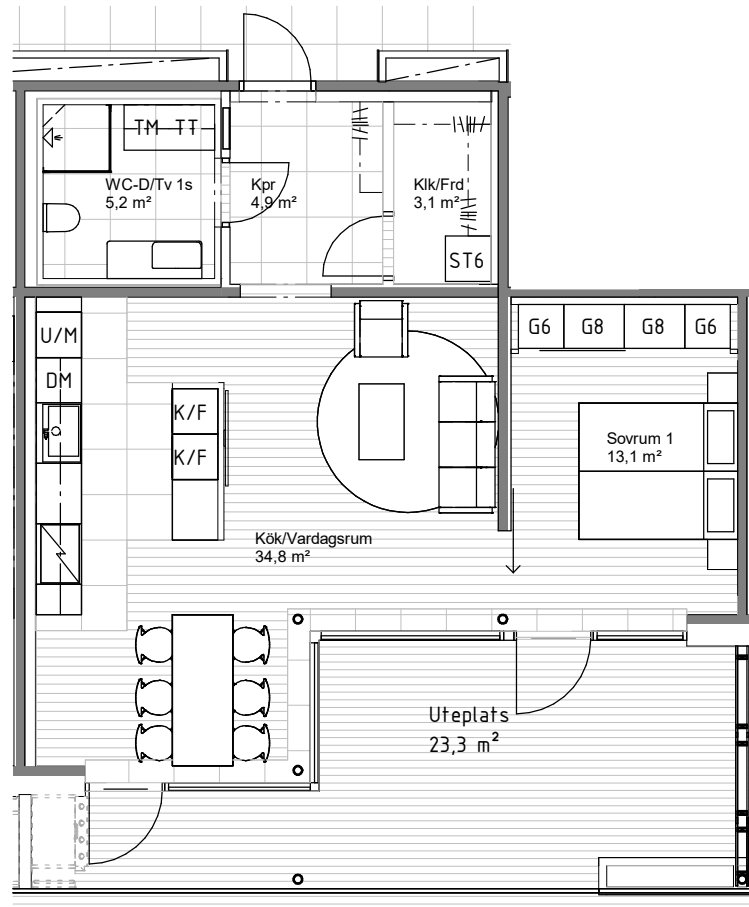

SKALA 1:100

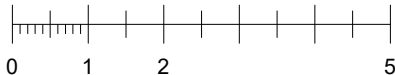

METER

PROJEKTUTVEKLAREN RESERVERAR SIG FÖR
EVENTUELLA ÄNDRINGAR OCH TRYCKFEL

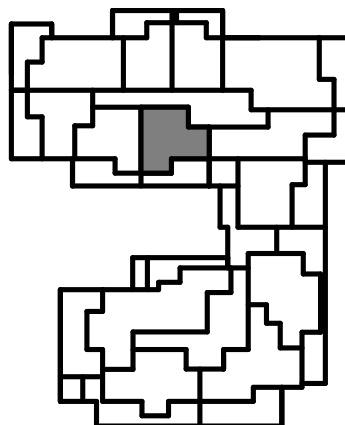

Kv 2, Råbylund, Lund

LGH NR:

11201

JOHAN SENNSTRÖM ARK SAR/MSA

2021-09-03, Rev.2023-12-05

2 RoK 63,1 Kvm + Uteplats 23 Kvm

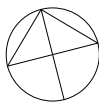
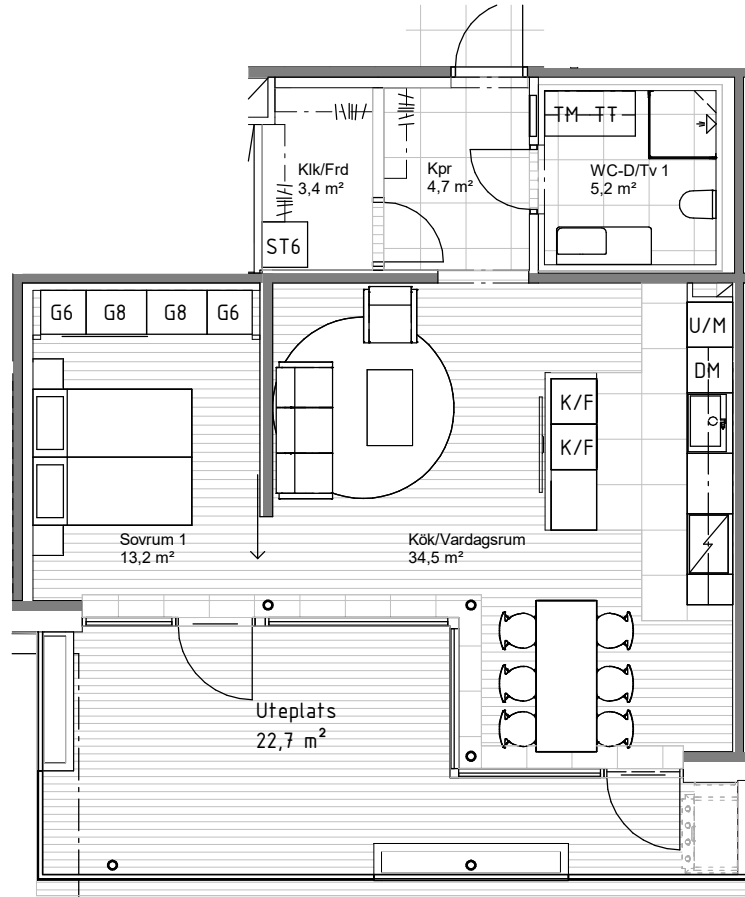

SKALA 1:100

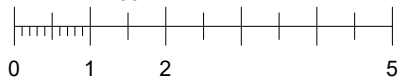

METER

PROJEKTUTVEKLAREN RESERVERAR SIG FÖR
EVENTUELLA ÄNDRINGAR OCH TRYCKFEL

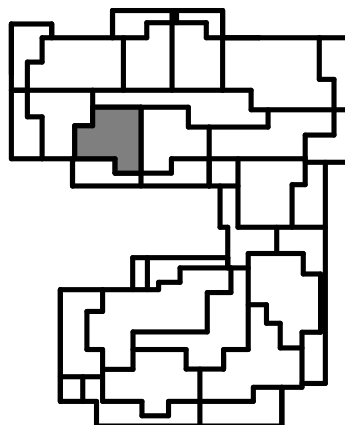

Kv 2, Råbylund, Lund

LGH NR:

11202

JOHAN SENNSTRÖM ARK SAR/MSA

2021-09-03, Rev.2023-12-05

2 RoK 58,5 + Uteplats 29 Kvm + 5,0 kvm externt förråd

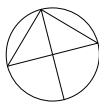
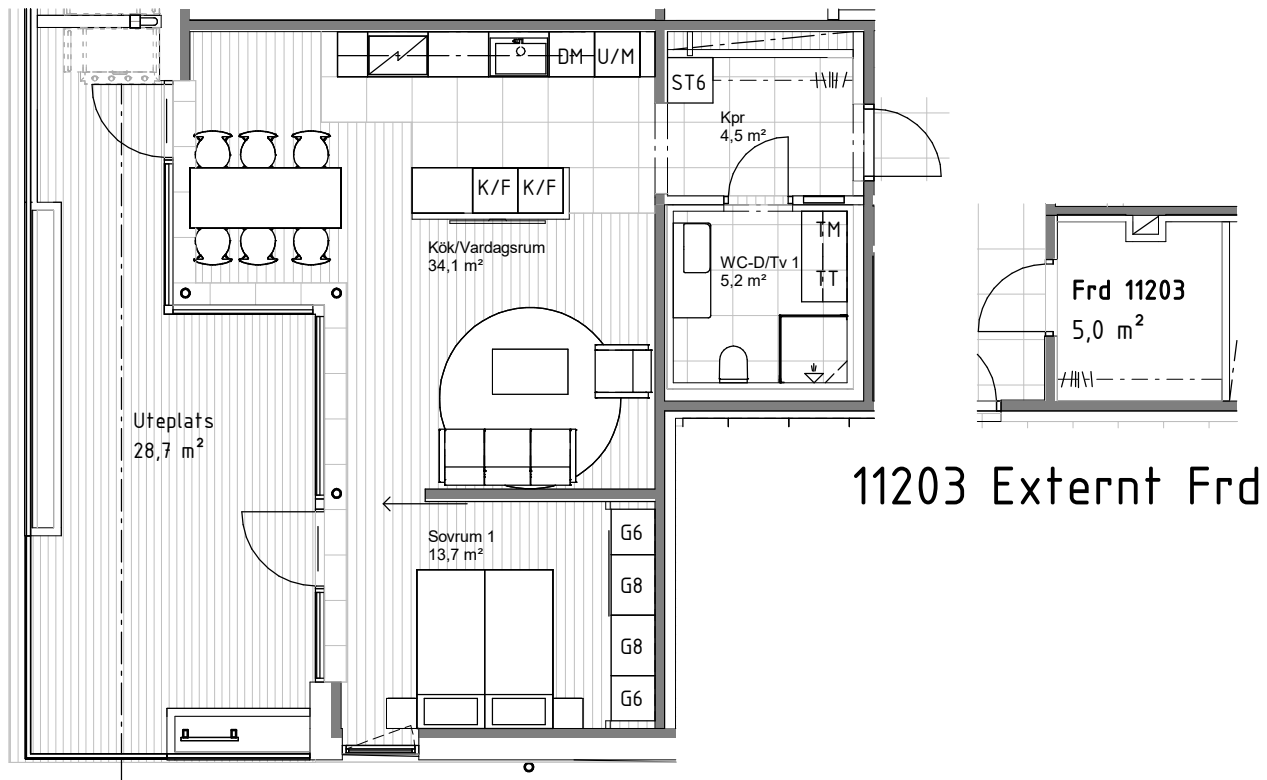

SKALA 1:100

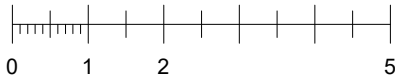

METER

PROJEKTUTVEKLAREN RESERVERAR SIG FÖR
EVENTUELLA ÄNDRINGAR OCH TRYCKFEL

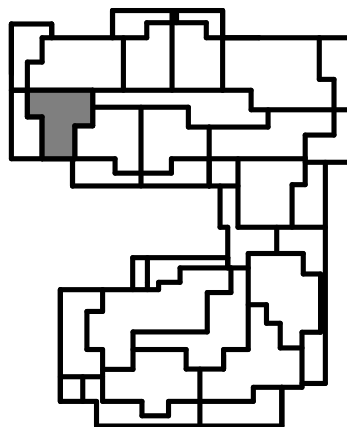

Kv 2, Råbylund, Lund

LGH NR:

11203

JOHAN SENNSTRÖM ARK SAR/MSA

2021-09-03, Rev.2023-12-05

3 RoK 82,7, Uteplats 28 Kvm + 4,5 Kvm Externt frd i källaren

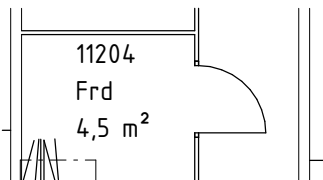
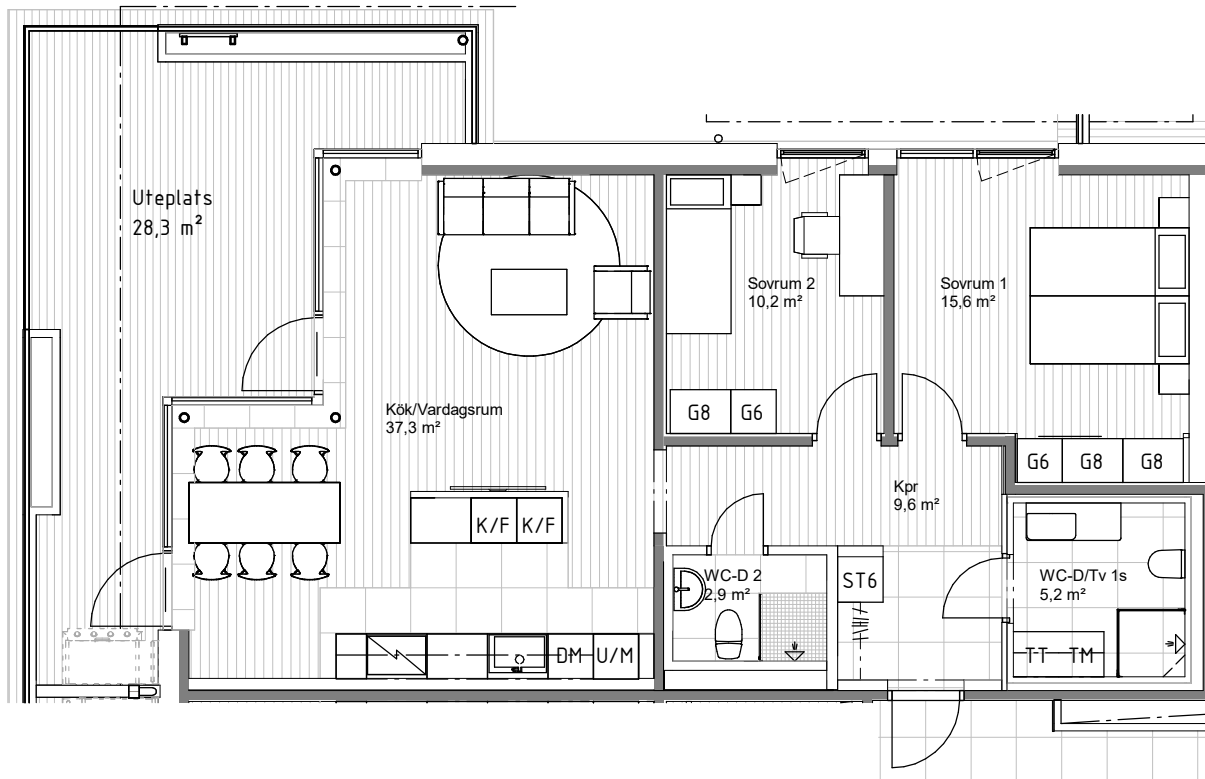

11204 Externt Frd

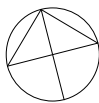

SKALA 1:100

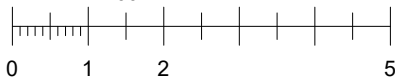

METER

PROJEKTUTVEKLAREN RESERVERAR SIG FÖR
EVENTUELLA ÄNDRINGAR OCH TRYCKFEL

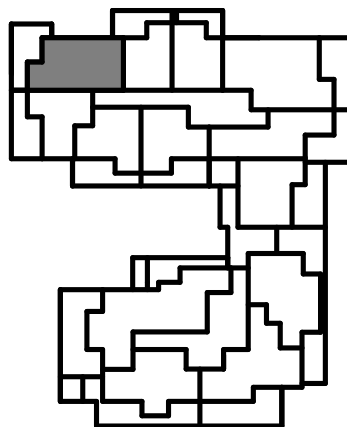

Kv 2, Råbylund, Lund

LGH NR:

11204

JOHAN SENNSTRÖM ARK SAR/MSA

2021-09-03, Rev.2023-12-05

2 RoK 52,7 Kvm + Uteplats 21 Kvm

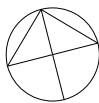
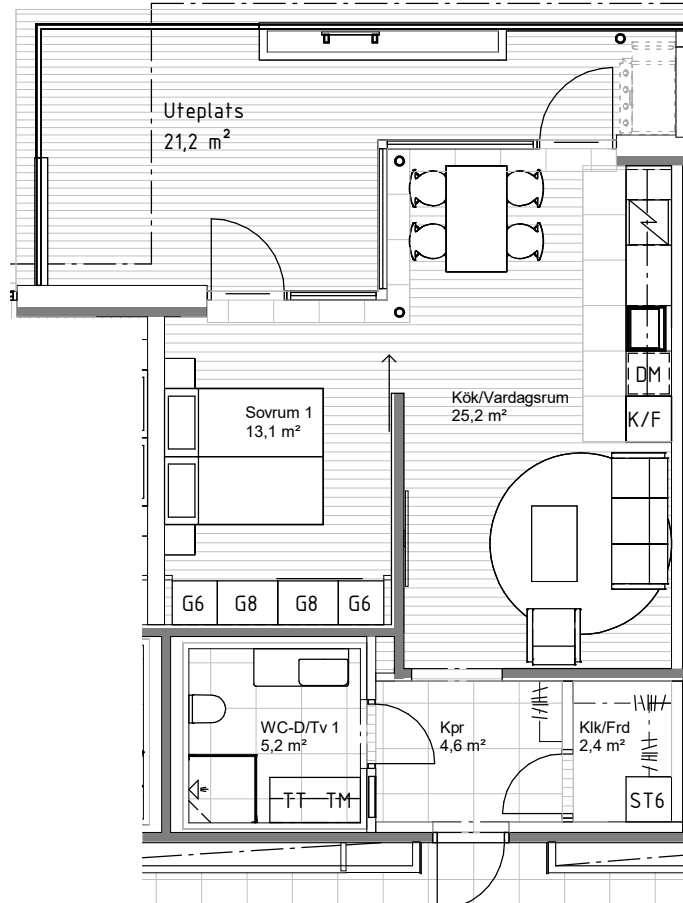

SKALA 1:100

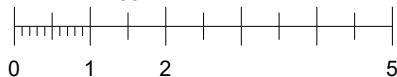

METER

PROJEKTUTVEKLAREN RESERVERAR SIG FÖR
EVENTUELLA ÄNDRINGAR OCH TRYCKFEL

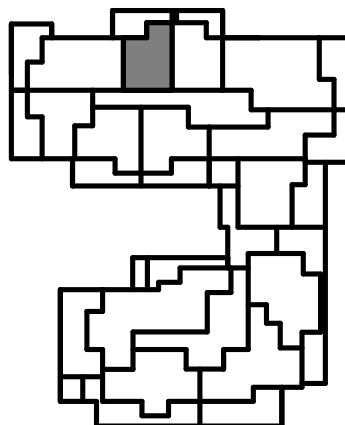

Kv 2, Råbylund, Lund

LGH NR:

11205

JOHAN SENNSTRÖM ARK SAR/MSA

2021-09-03, Rev.2023-12-05

2 RoK 52,7 Kvm + Uteplats 16 Kvm

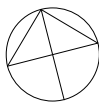
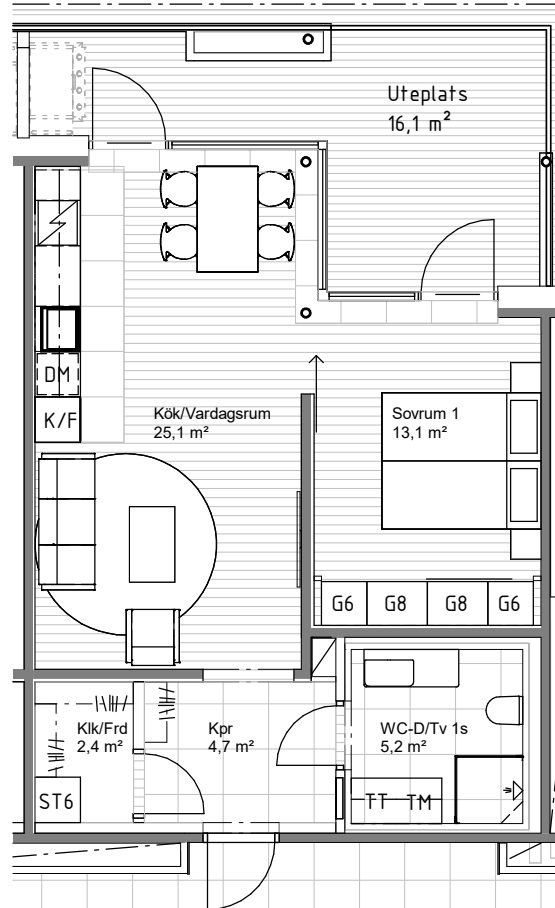

SKALA 1:100

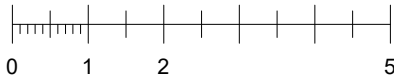

METER

PROJEKTUTVEKLAREN RESERVERAR SIG FÖR
EVENTUELLA ÄNDRINGAR OCH TRYCKFEL

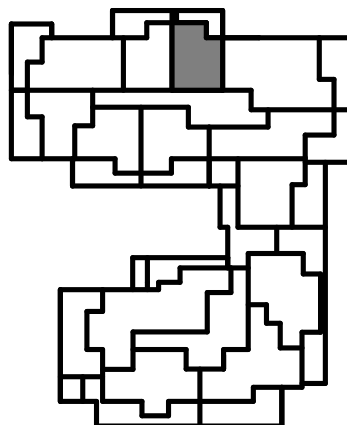

Kv 2, Råbylund, Lund

LGH NR:

11206

JOHAN SENNSTRÖM ARK SAR/MSA

2021-09-03, Rev.2023-12-05

4 RoK 96,2 Kvm + Uteplats 33 Kvm

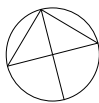
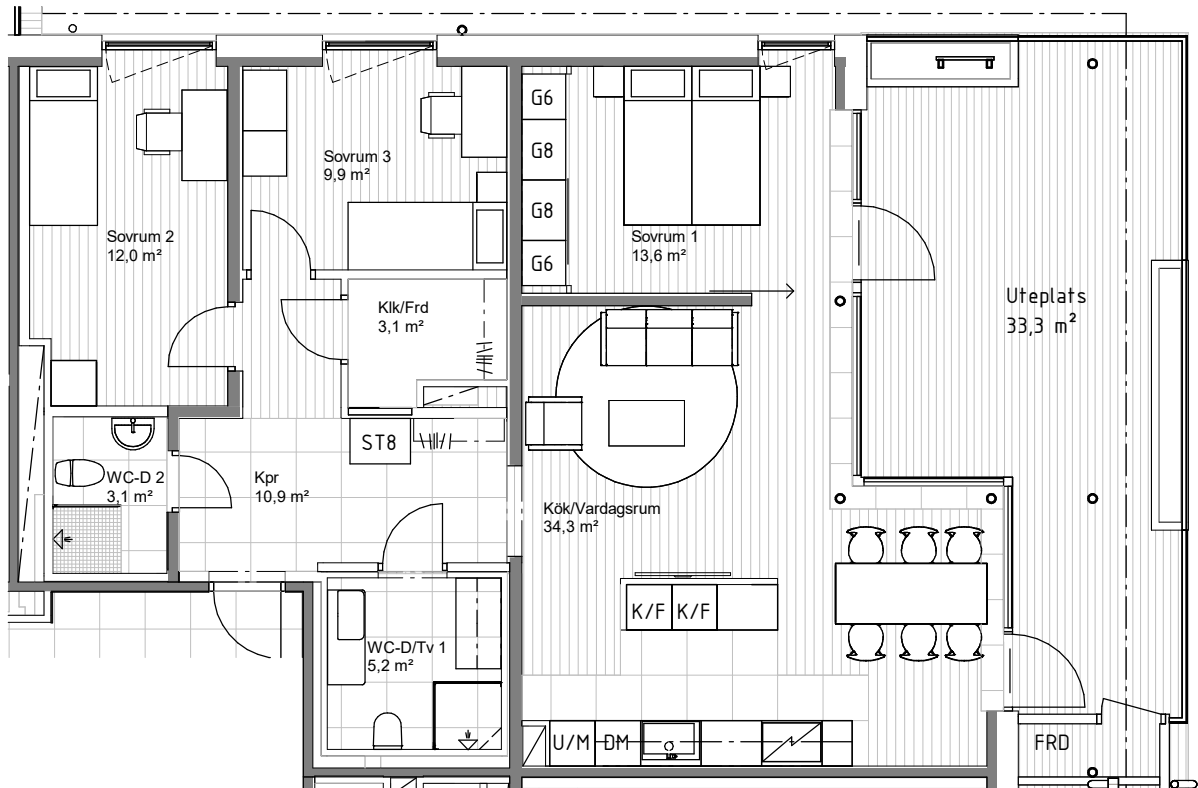

SKALA 1:100

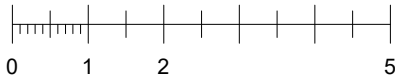

METER

PROJEKTUTVEKLAREN RESERVERAR SIG FÖR
EVENTUELLA ÄNDRINGAR OCH TRYCKFEL

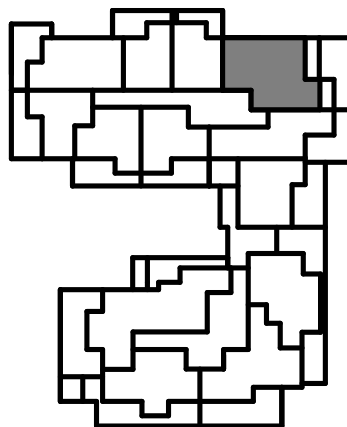

Kv 2, Råbylund, Lund

LGH NR:

11207

JOHAN SENNSTRÖM ARK SAR/MSA

2021-09-03, Rev.2023-12-05

2 RoK 70,4 Kvm + Uteplats 24 + 12 Kvm

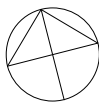
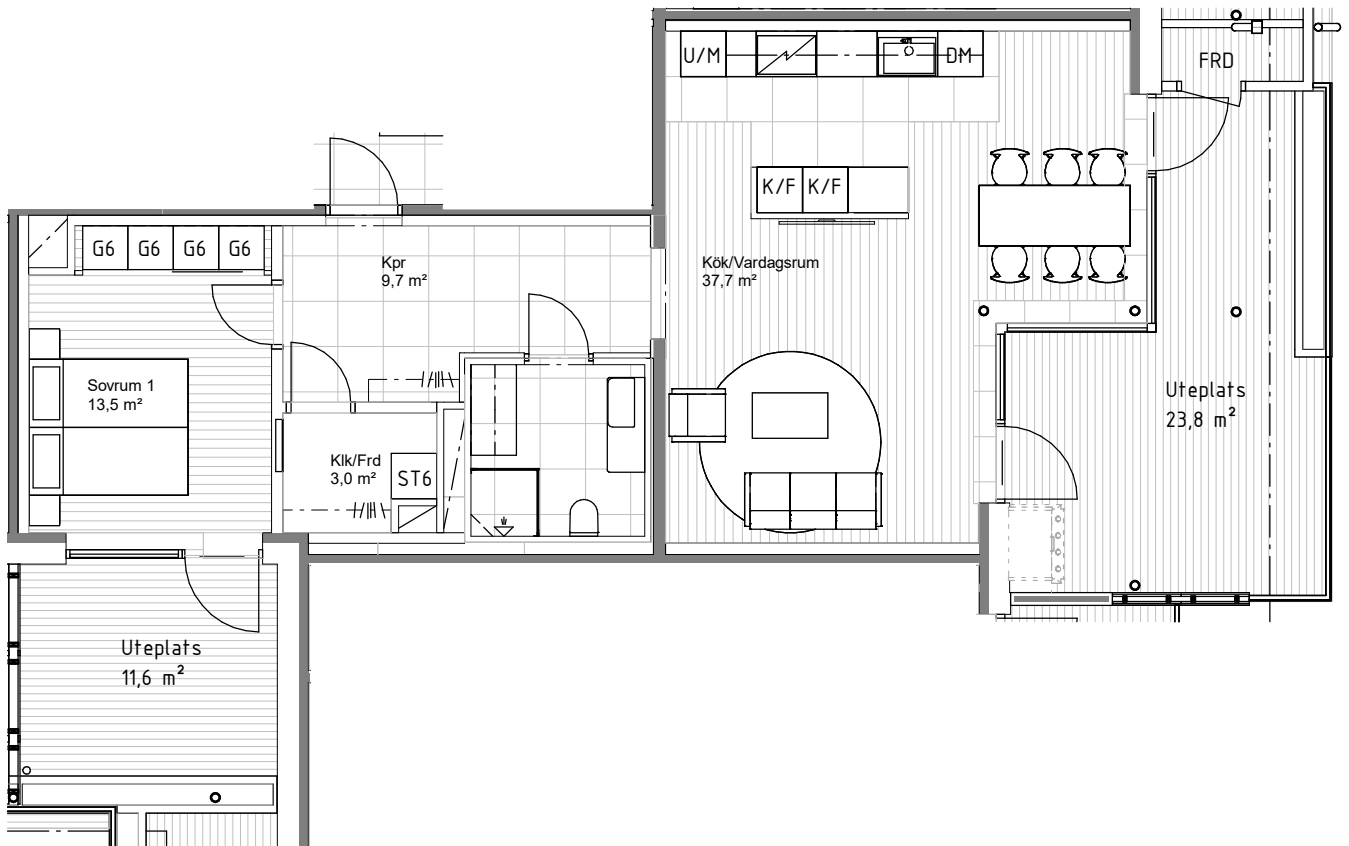

SKALA 1:100

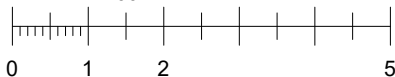

METER

PROJEKTUTVECKLAREN RESERVERAR SIG FÖR
EVENTUELLA ÄNDRINGAR OCH TRYCKFEL

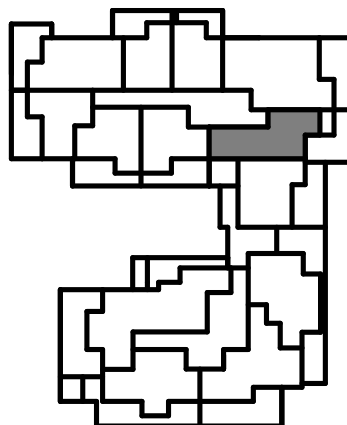

Kv 2, Råbylund, Lund

LGH NR:

11208

JOHAN SENNSTRÖM ARK SAR/MSA

2021-09-03, Rev.2023-12-05

3 RoK 84,9 Kvm + Uteplats 23 Kvm

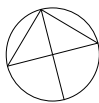
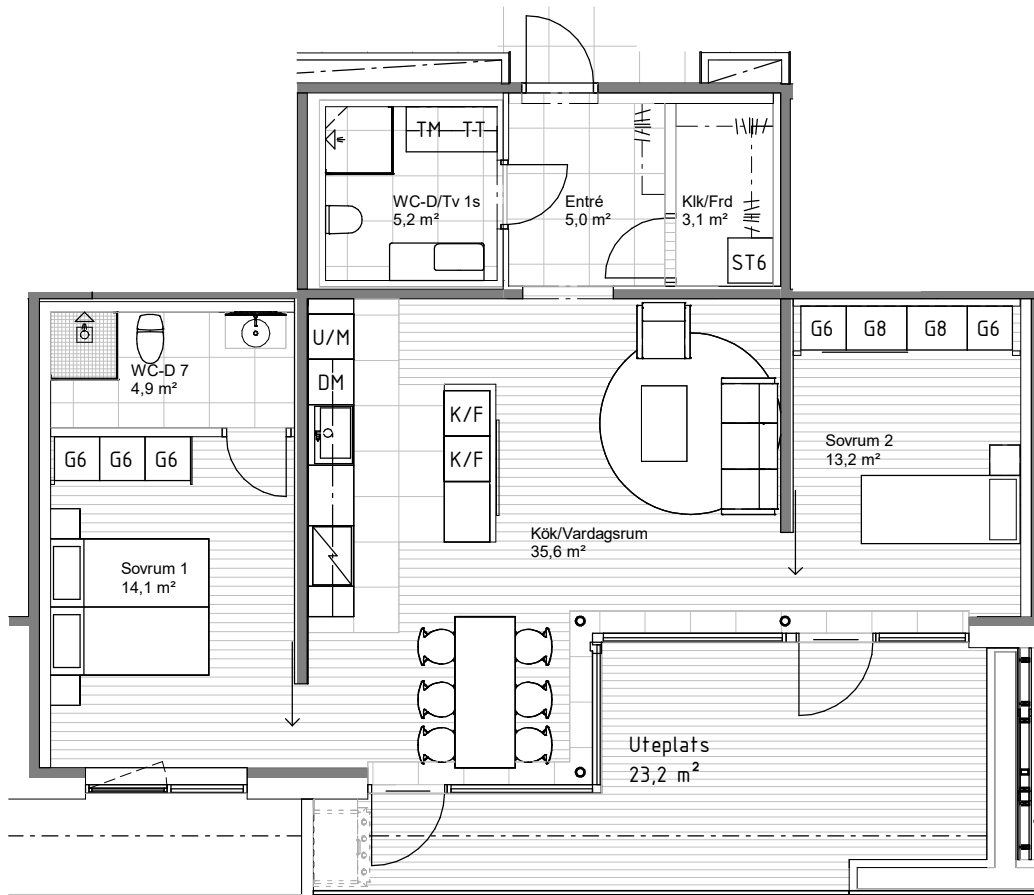

SKALA 1:100

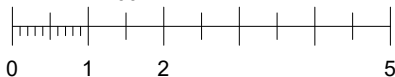

METER

PROJEKTUTVEKLAREN RESERVERAR SIG FÖR
EVENTUELLA ÄNDRINGAR OCH TRYCKFEL

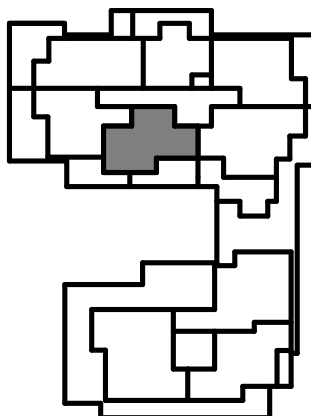

Kv 2, Råbylund, Lund

LGH NR:

11301

JOHAN SENNSTRÖM ARK SAR/MSA

2021-09-03, Rev.2023-12-05

3 RoK 82,5 Kvm + Uteplats 40 Kvm + 5,1 Kvm ext. Frd

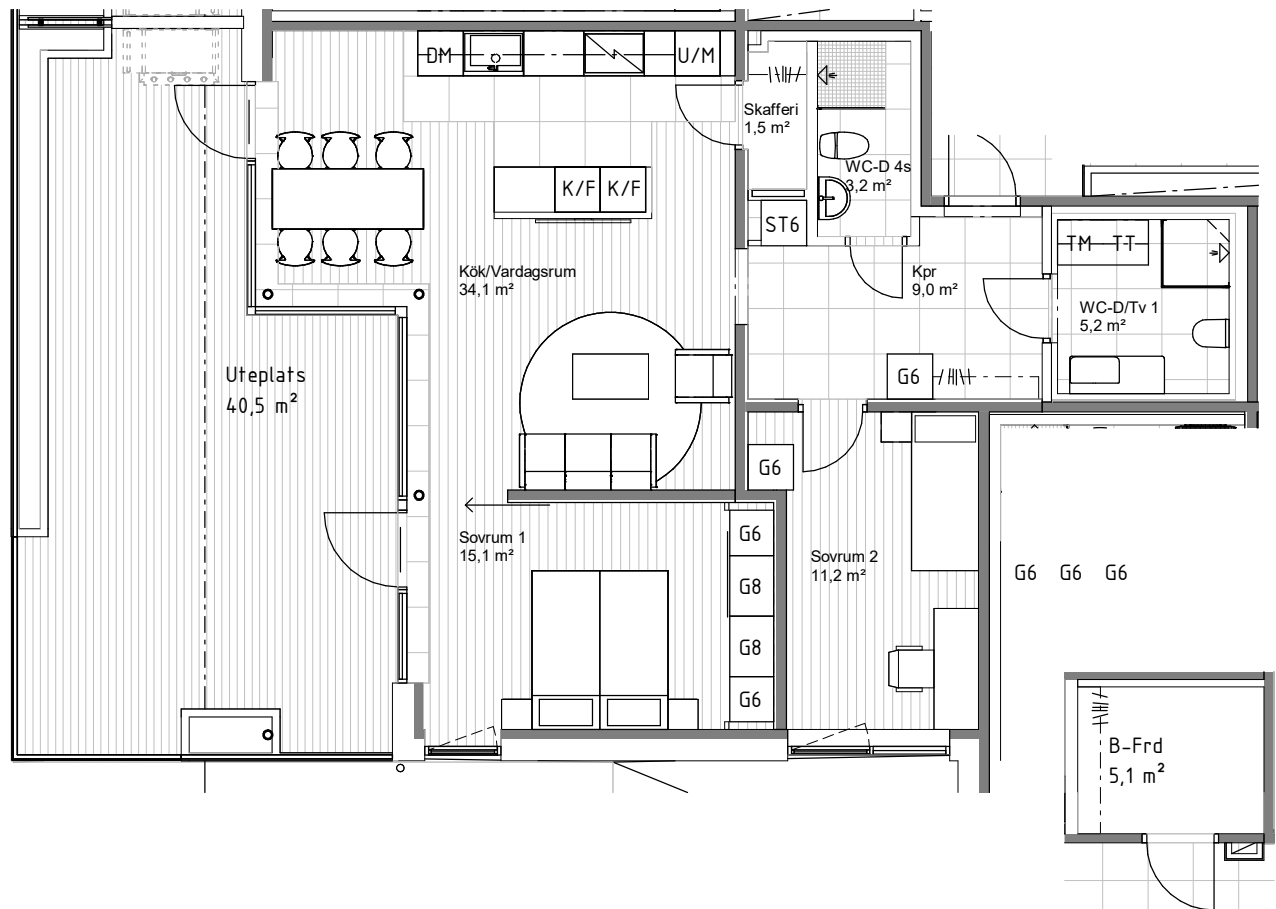

11302 Externt förråd

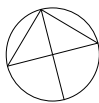

SKALA 1:100

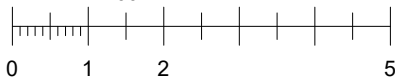

METER

PROJEKTUTVEKLAREN RESERVERAR SIG FÖR
EVENTUELLA ÄNDRINGAR OCH TRYCKFEL

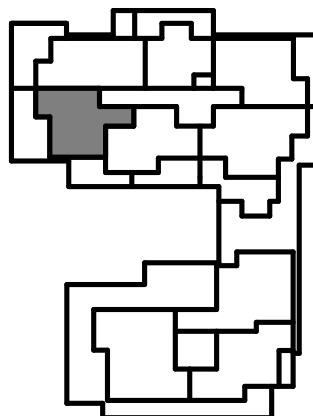

Kv 2, Råbylund, Lund

LGH NR:

11302

JOHAN SENNSTRÖM ARK SAR/MSA

2021-09-03, Rev.2023-12-05

4 RoK 93,6 Kvm + Uteplats 39 Kvm

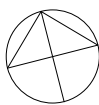
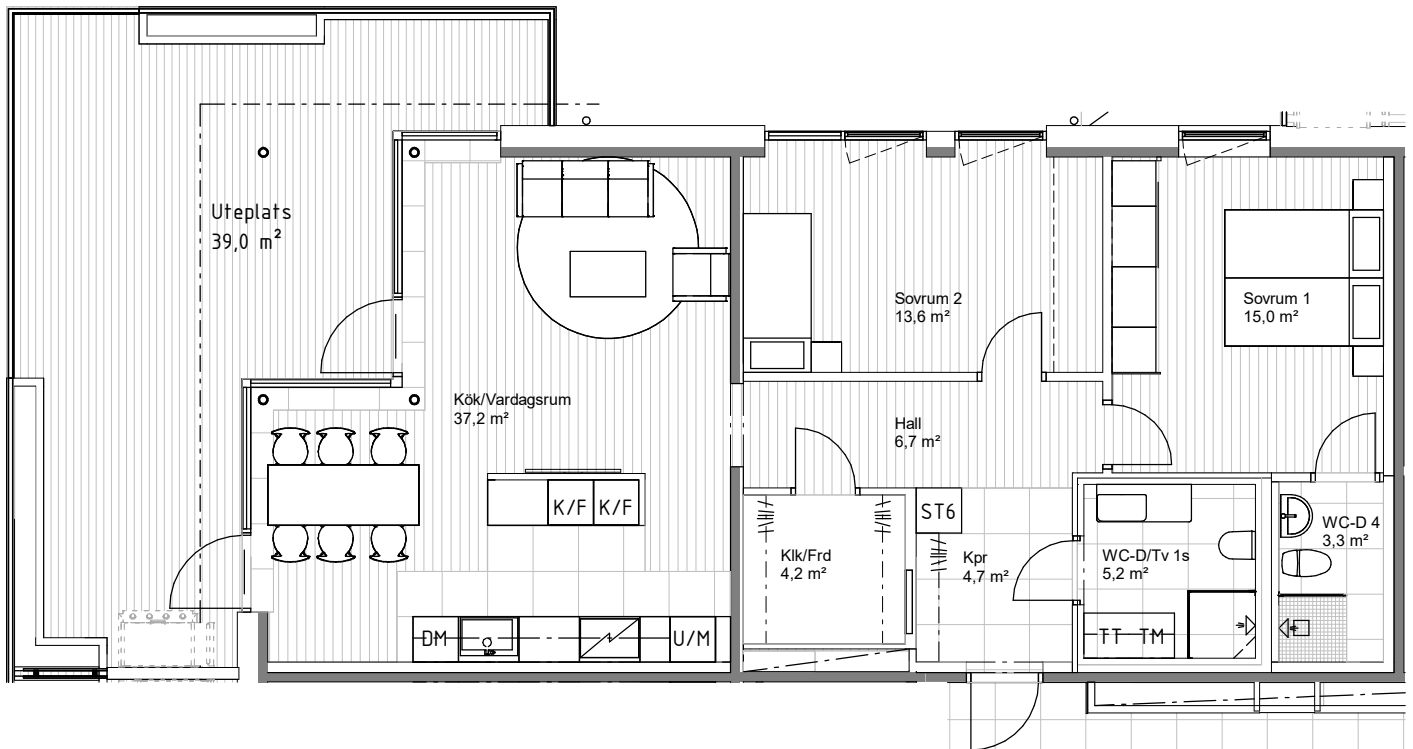

SKALA 1:100

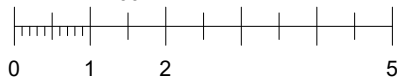

METER

PROJEKTUTVEKLAREN RESERVERAR SIG FÖR
EVENTUELLA ÄNDRINGAR OCH TRYCKFEL

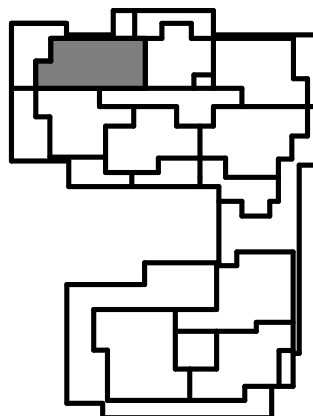

Kv 2, Råbylund, Lund

LGH NR:

11303

JOHAN SENNSTRÖM ARK SAR/MSA

2021-09-03, Rev.2023-12-05

2 RoK 64,9 Kvm + Uteplats 29 Kvm

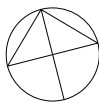
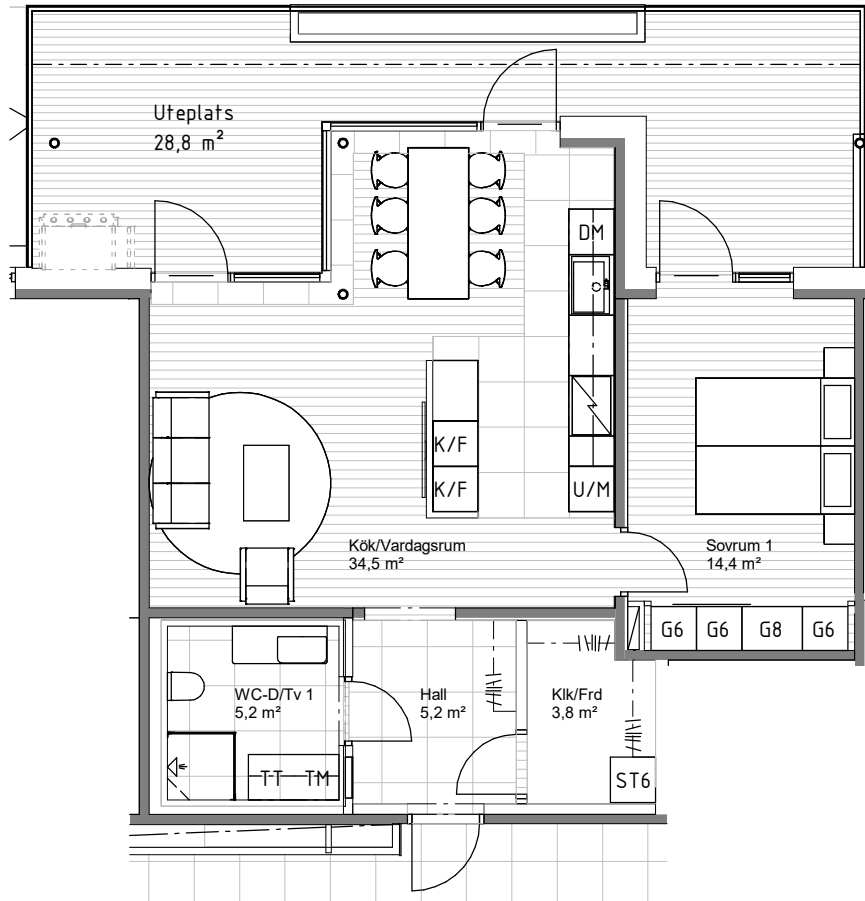

SKALA 1:100

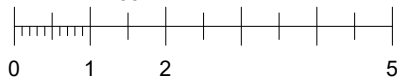

METER

PROJEKTUTVEKLAREN RESERVERAR SIG FÖR
EVENTUELLA ÄNDRINGAR OCH TRYCKFEL

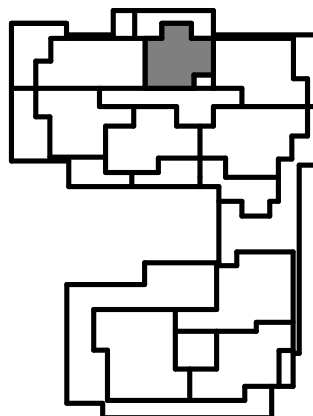

Kv 2, Råbylund, Lund

LGH NR:

11304

JOHAN SENNSTRÖM ARK SAR/MSA

2021-09-03, Rev.2023-12-05

4 RoK 96,2 Kvm + Uteplats 22 Kvm

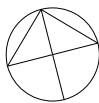
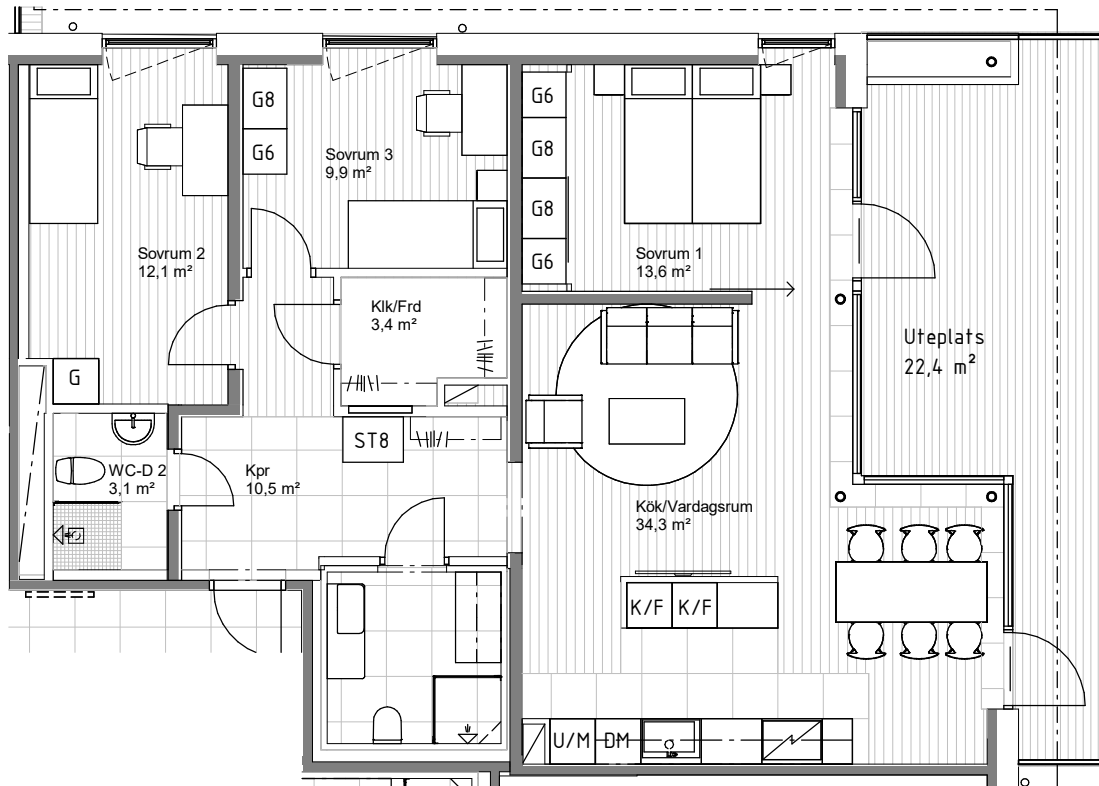

SKALA 1:100

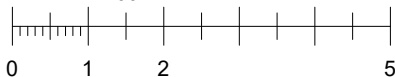

METER

PROJEKTUTVEKLAREN RESERVERAR SIG FÖR
EVENTUELLA ÄNDRINGAR OCH TRYCKFEL

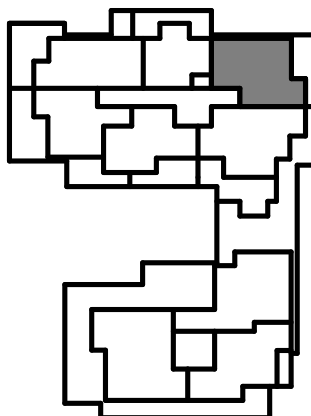

Kv 2, Råbylund, Lund

LGH NR:

11305

JOHAN SENNSTRÖM ARK SAR/MSA

2021-09-03, Rev.2023-12-05

4 Rok 106,4 Kvm + Uteplats 70 Kvm inkl. ev. Bastu/Uterum

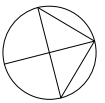
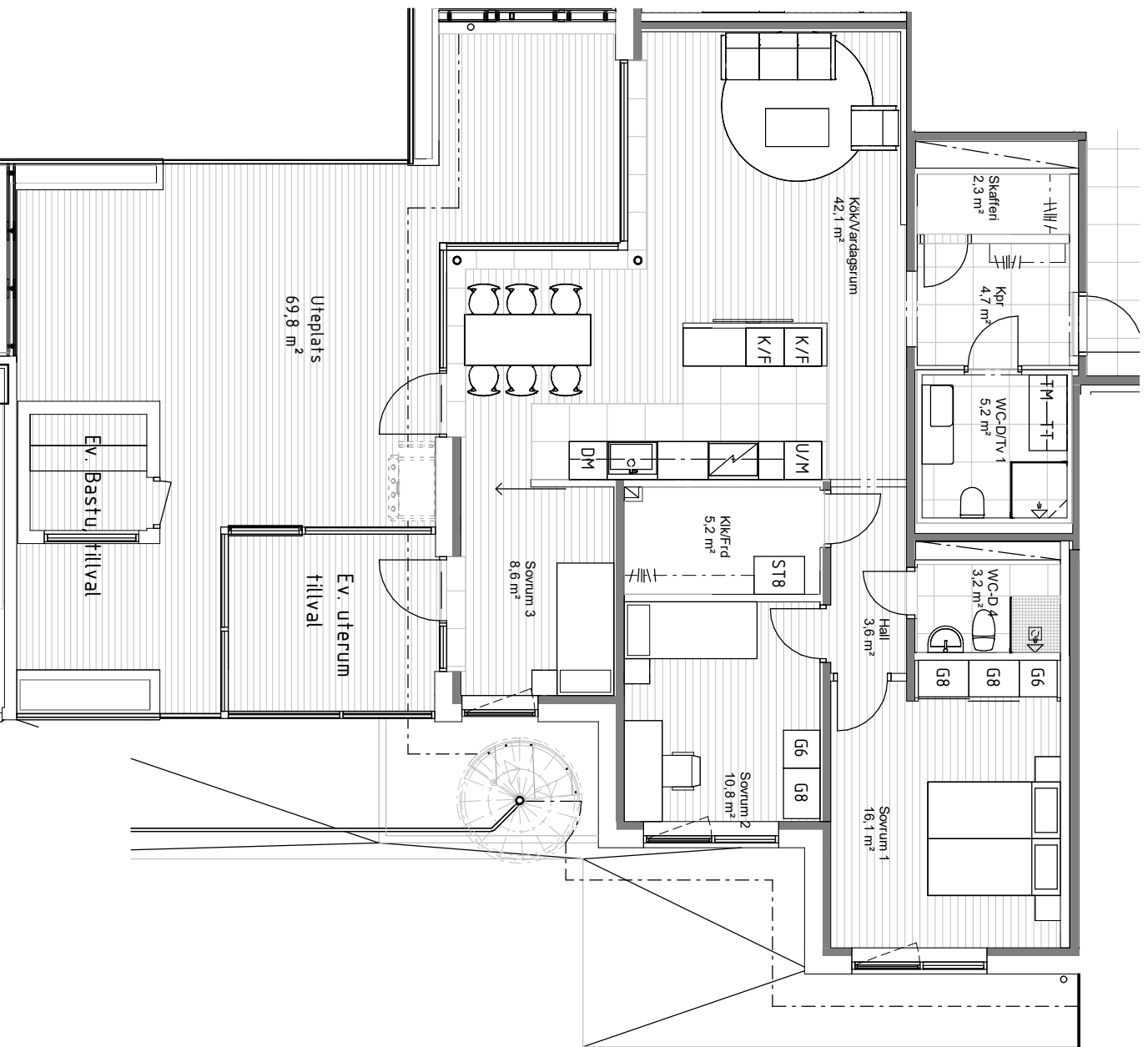

SKALA 1:100

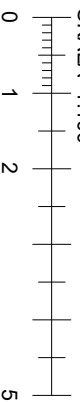

METER

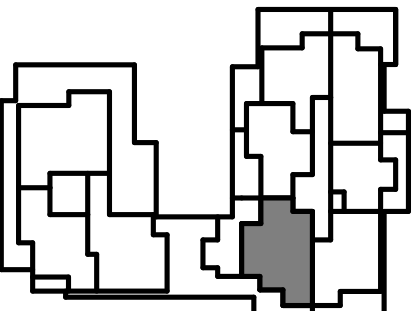

Kv 2, Råbylund, Lund

LGH NR:

11306

JOHAN SENNSTRÖM ARK SARIMSA

PROJEKTUTVEKLAREN RESERVERAR SIG FÖR
EVENTUELLA ÄNDRINGAR OCH TRYCKFEL

2021-09-03, Rev.2023-12-05

2 ROK 62,7 KvM + Uteplats 24 KvM

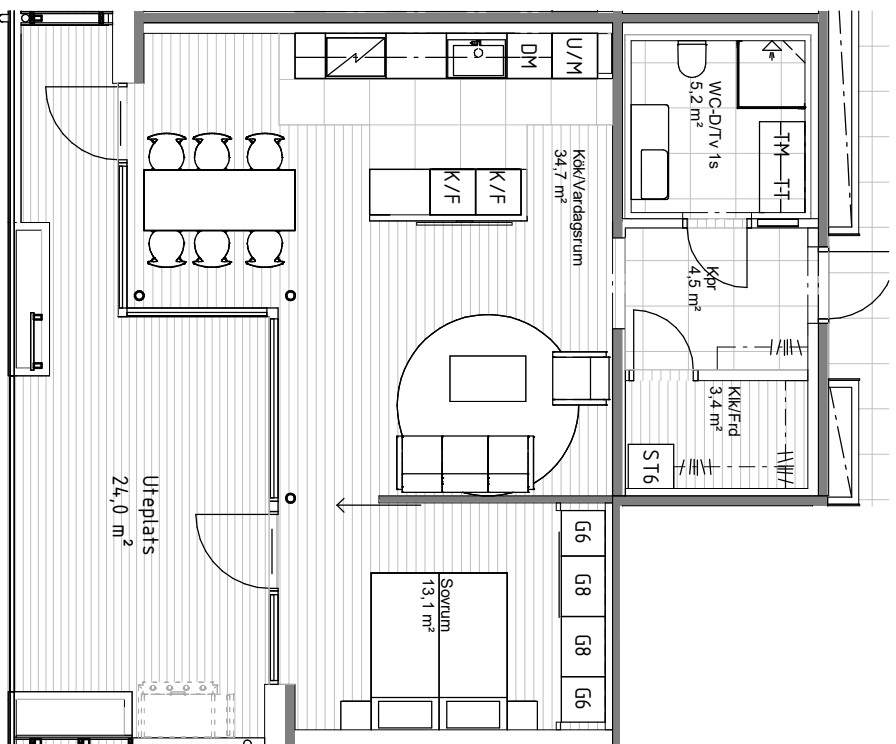

SKALA 1:100

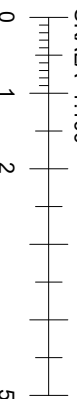

METER

Parkstråk med GC- och bilväg

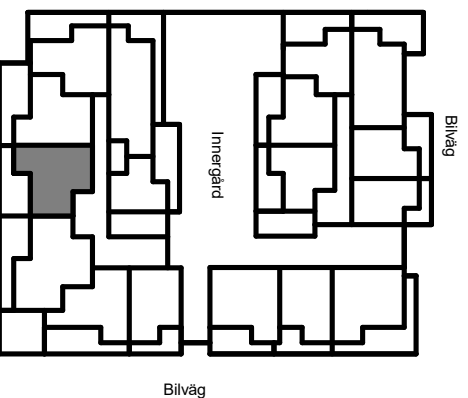

ÖVERSIKTSPLAN, PLACERING LGH (1:1000)

Kv 2, Råbylund, Lund

LGH NR:

21001

JOHAN SENNSTRÖM ARK SARIMSA

2021-09-03, Rev.2024-05-26

2 RoK 62,8 Kvm + Uteplats 30 Kvm

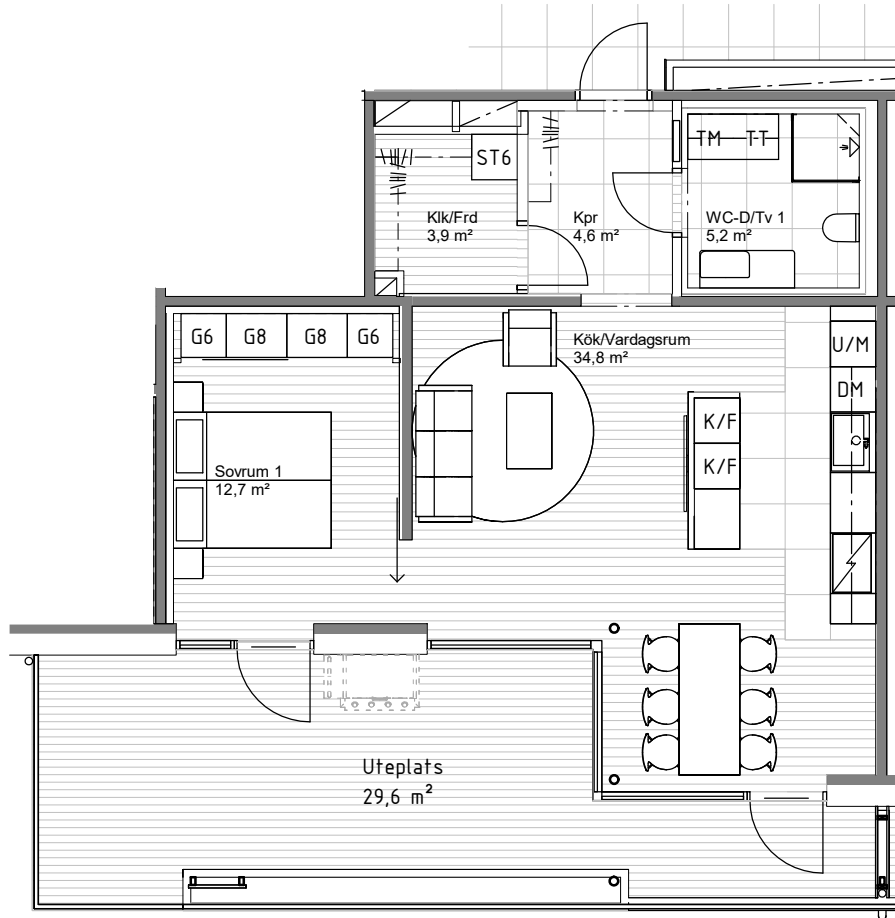

SKALA 1:100

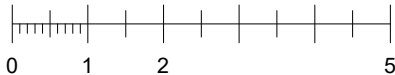

METER

PROJEKTUTVEKLAREN RESERVERAR SIG FÖR
EVENTUELLA ÄNDRINGAR OCH TRYCKFEL

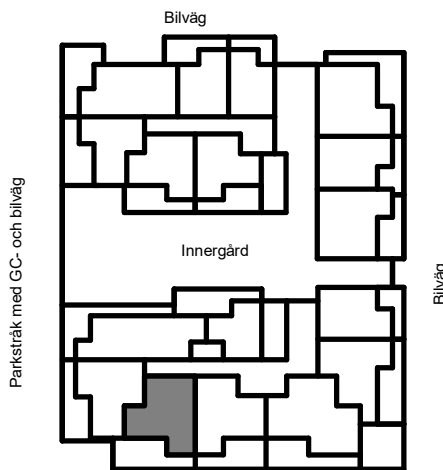

ÖVERSIKTSPLAN, PLACERING LGH (1:1000)

Kv 2, Råbylund, Lund

LGH NR:

21002

JOHAN SENNSTRÖM ARK SAR/MSA

2021-09-03, Rev.2024-05-26

2 Rok 58,4 Kvm + Uteplats 28 Kvm + 3,7 Kvm externt Frd

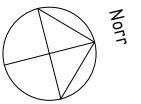
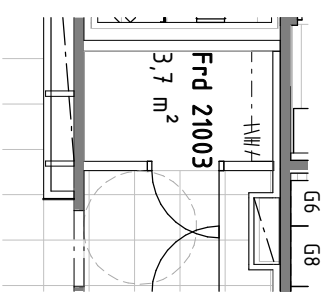
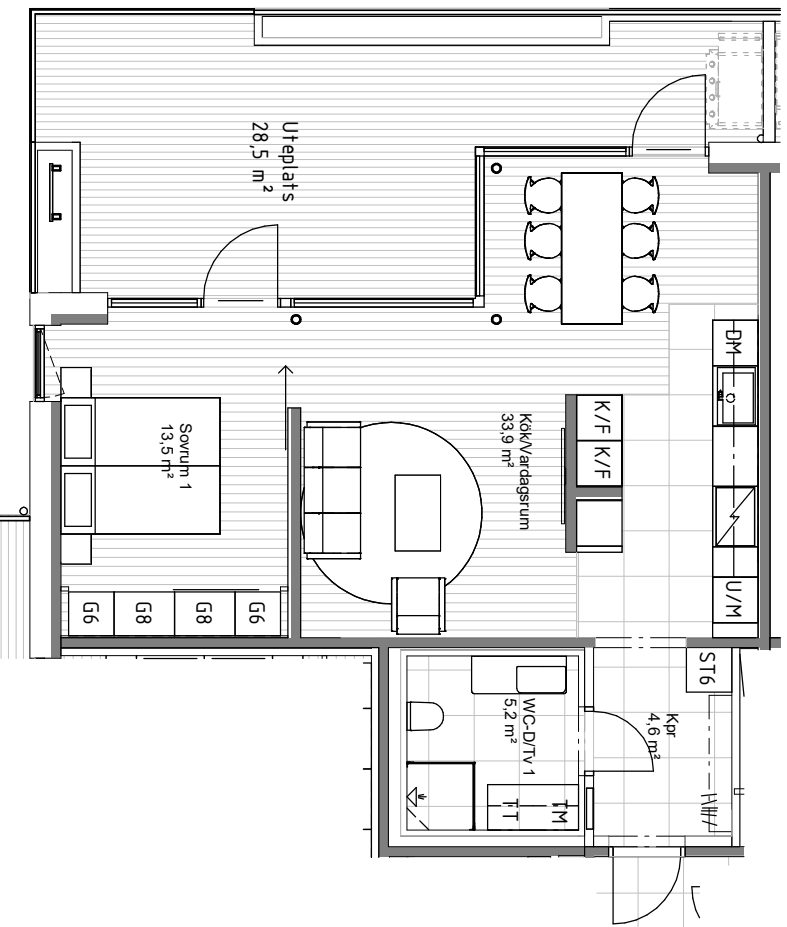

SKALA 1:100

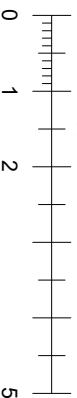

METER

Parkstråk med GC- och bilväg

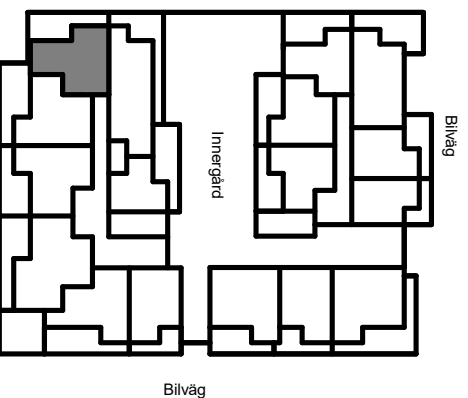

ÖVERSIKTSPLAN, PLACERING LGH (1:1000)

Kv 2, Råbylund, Lund

LGH NR:

21003

JOHAN SENNSTRÖM ARK SARMSA

2021-09-03, Rev.2024-05-26

3 ROK 92,3 KvM + Uteplats 47 KvM

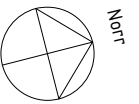
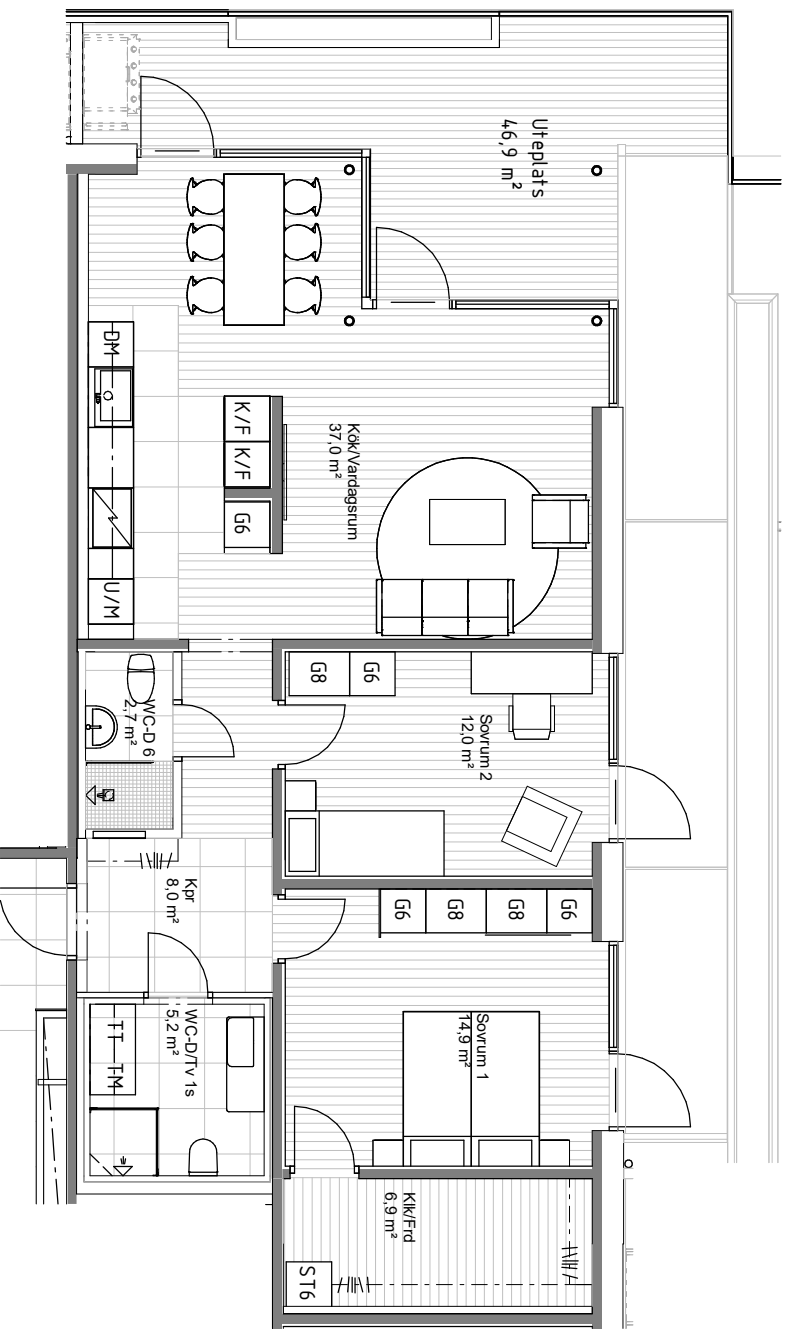

SKALA 1:100

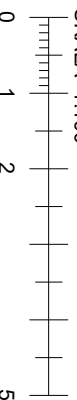

METER

Parkstråk med GC- och bilväg

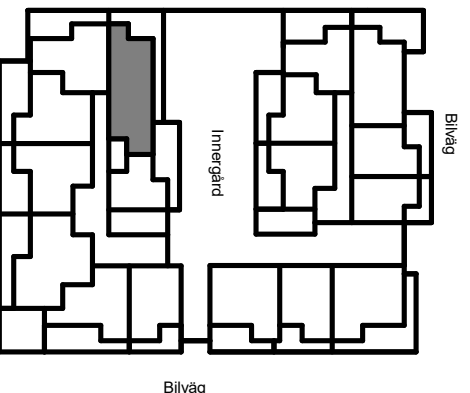

ÖVERSIKTSPLAN, PLACERING LGH (1:1000)

Kv 2, Råbylund, Lund

LGH NR:

21004

JOHAN SENNSTRÖM ARK SARMSA

2021-09-03, Rev.2024-05-26

2 RoK 61,8 Kvm + Uteplats 37 Kvm

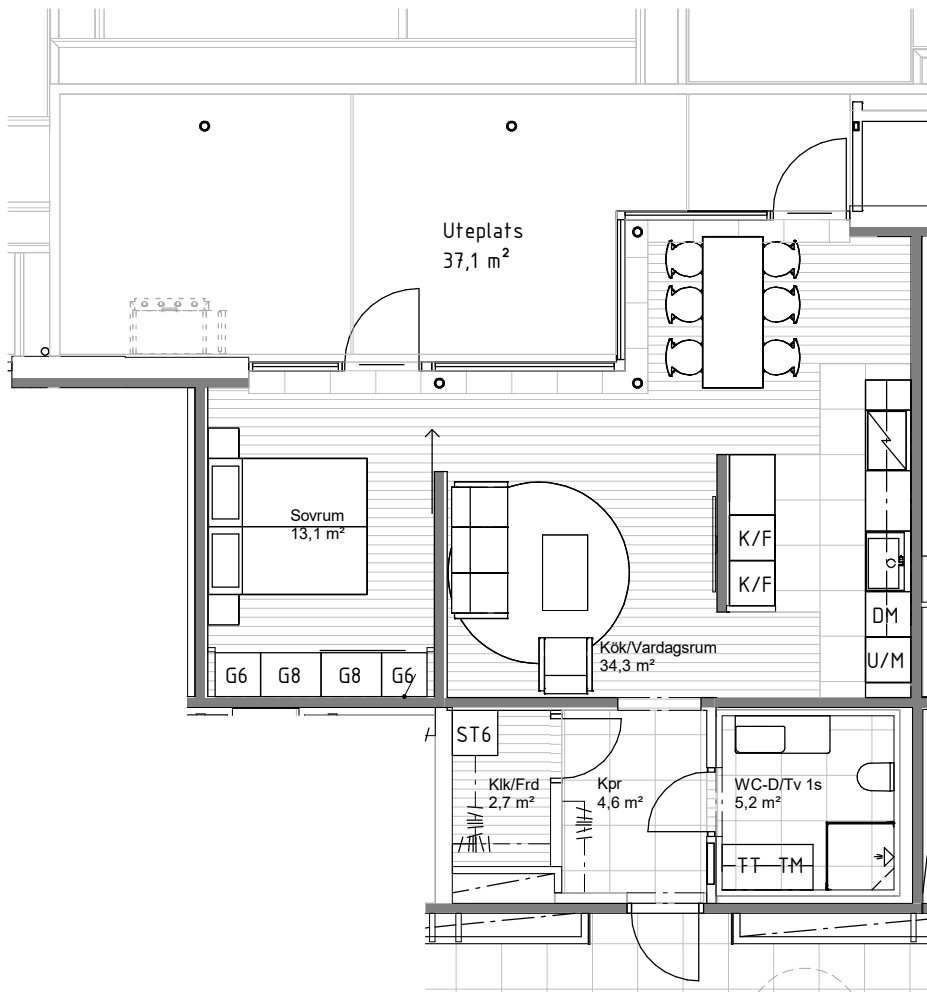

SKALA 1:100

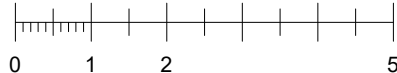

METER

PROJEKTUTVECKLAREN RESERVERAR SIG FÖR
EVENTUELLA ÄNDRINGAR OCH TRYCKFEL

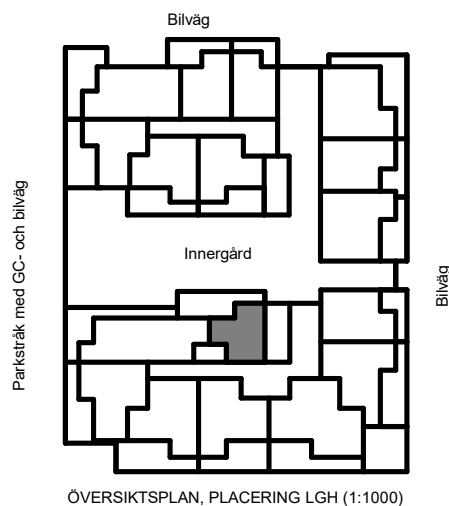

Kv 2, Råbylund, Lund

LGH NR:

21005

JOHAN SENNSTRÖM ARK SAR/MSA

2021-09-03, Rev.2023-12-05

2 Rok 54,7 Kv_m + Frd 7,0 Kv_m + Uteplats 16 Kv_m

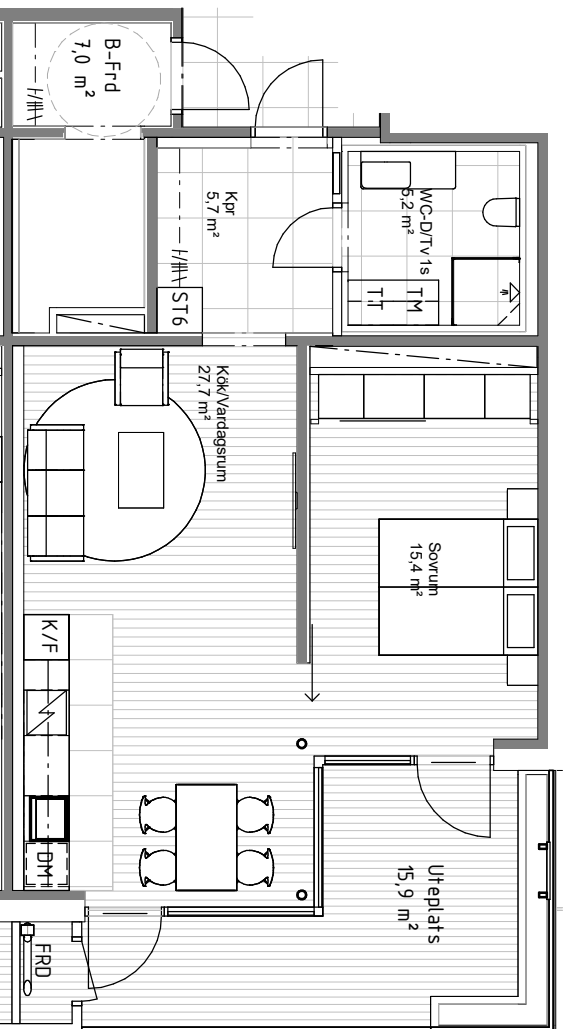

/

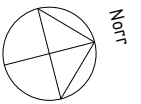

SKALA 1:100

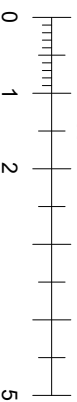

METER

Parkstråk med GC- och bilväg

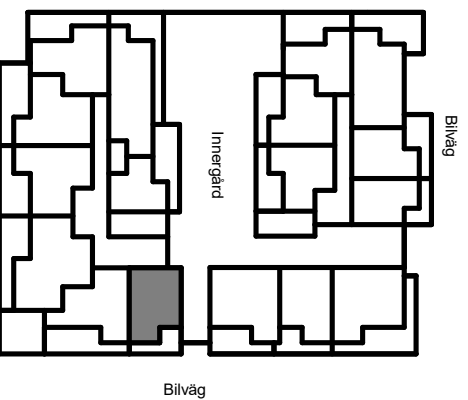

PROJEKTUTVECKLAREN RESERVERAR SIG FÖR
EVENTUELLA ÄNDRINGAR OCH TRYCKFEL

ÖVERSIKTSPLAN, PLACERING LGH (1:1000)

Kv 2, Råbylund, Lund

LGH NR:

21006

JOHAN SENNSTRÖM ARK SARMISA

2021-09-03, Rev.2024-05-26

2 Rok 73,9 Kv_m + Uteplats 32 Kv_m

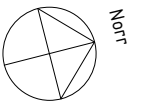
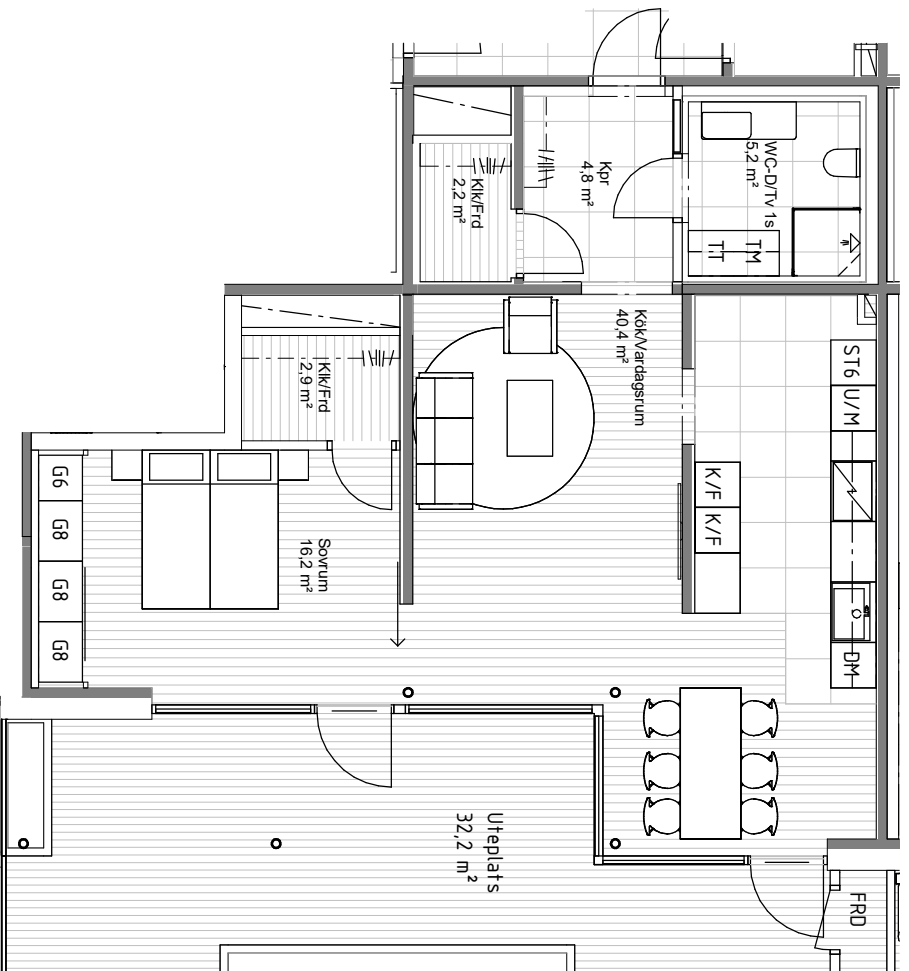

SKALA 1:100

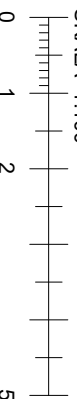

METER

Parkstråk med GC- och bilväg

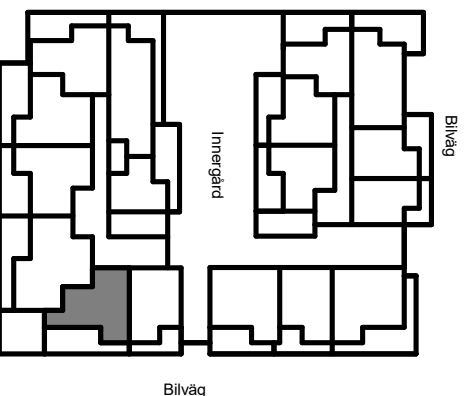

ÖVERSIKTSPLAN, PLACERING LGH (1:1000)

Kv 2, Råbylund, Lund

LGH NR:

21007

JOHAN SENNSTRÖM ARK SARMSA

2021-09-03, Rev.2024-05-26

PROJEKTUTVEKLAREN RESERVERAR SIG FÖR
EVENTUELLA ÄNDRINGAR OCH TRYCKFEL

3 ROK 82,9 KvM + Uteplats 29 KvM

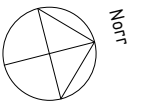
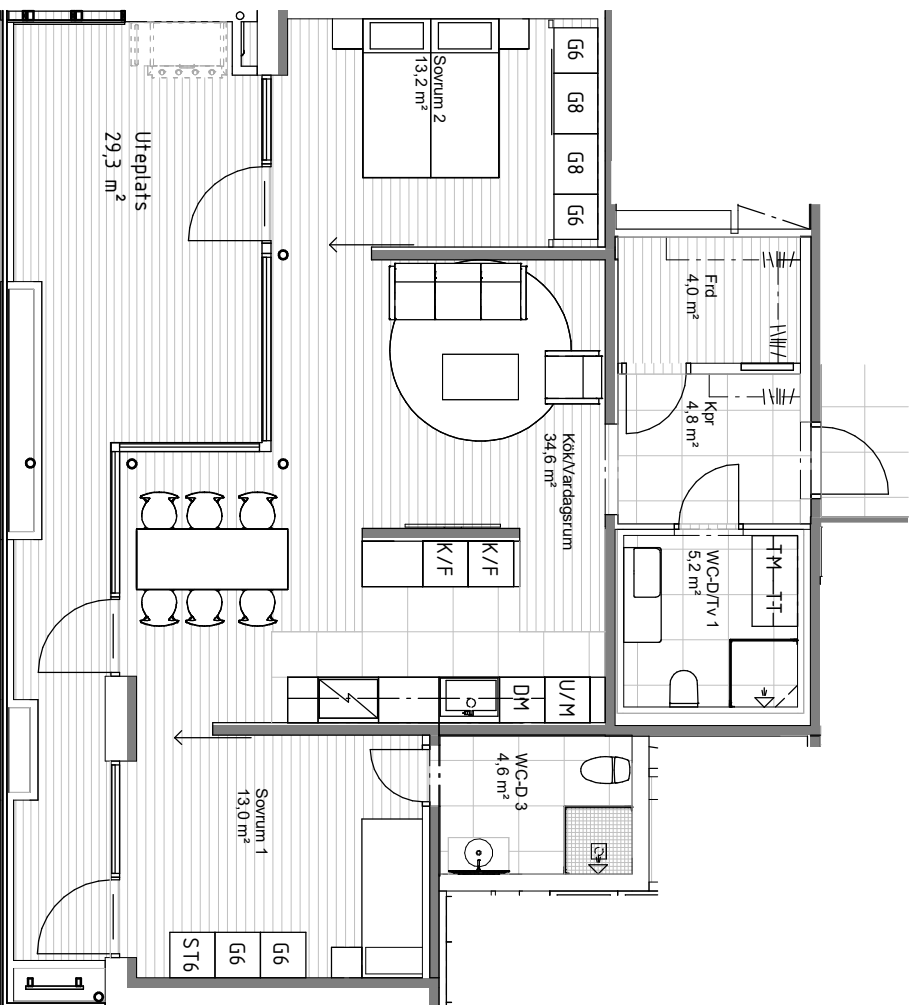

SKALA 1:100

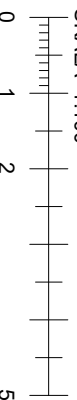

METER

Parkstråk med GC- och bilväg

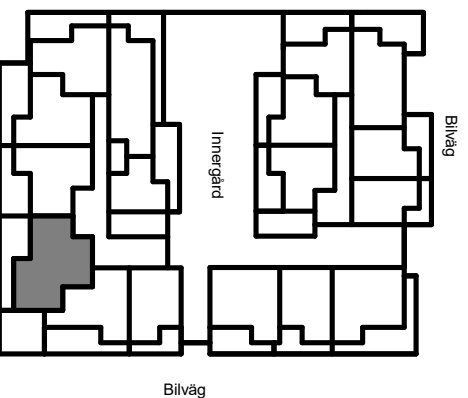

ÖVERSIKTSPLAN, PLACERING LGH (1:1000)

Kv 2, Råbylund, Lund

LGH NR:

21008

JOHAN SENNSTRÖM ARK SARMISA

2021-09-03, Rev.2024-05-26

2 RoK 62,7 Kvm + Uteplats 24 Kvm

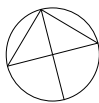
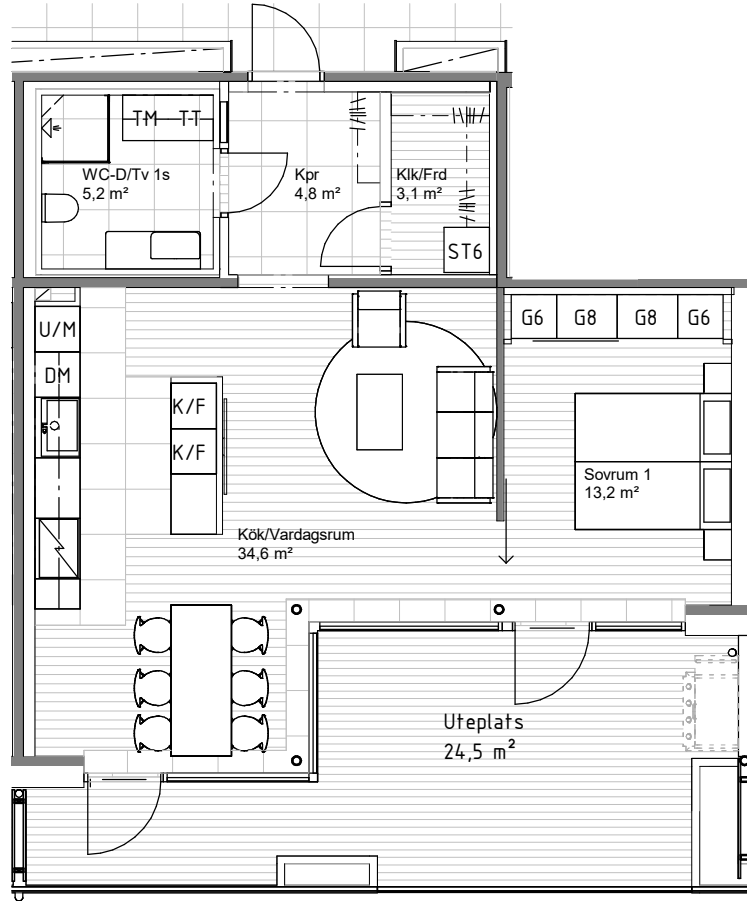

SKALA 1:100

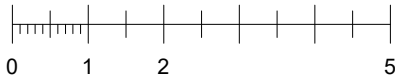

METER

PROJEKTUTVECKLAREN RESERVERAR SIG FÖR
EVENTUELLA ÄNDRINGAR OCH TRYCKFEL

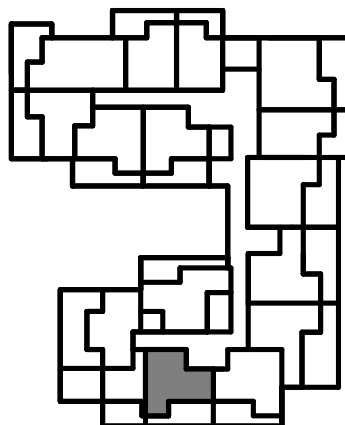

Kv 2, Råbylund, Lund

LGH NR:

21101

JOHAN SENNSTRÖM ARK SAR/MSA

2021-09-03, Rev.2023-12-05

2 Rok 60,4 Kvm + Uteplats 25 Kvm + 3,5 Kvm Externt frd

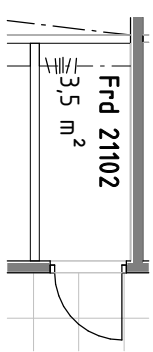
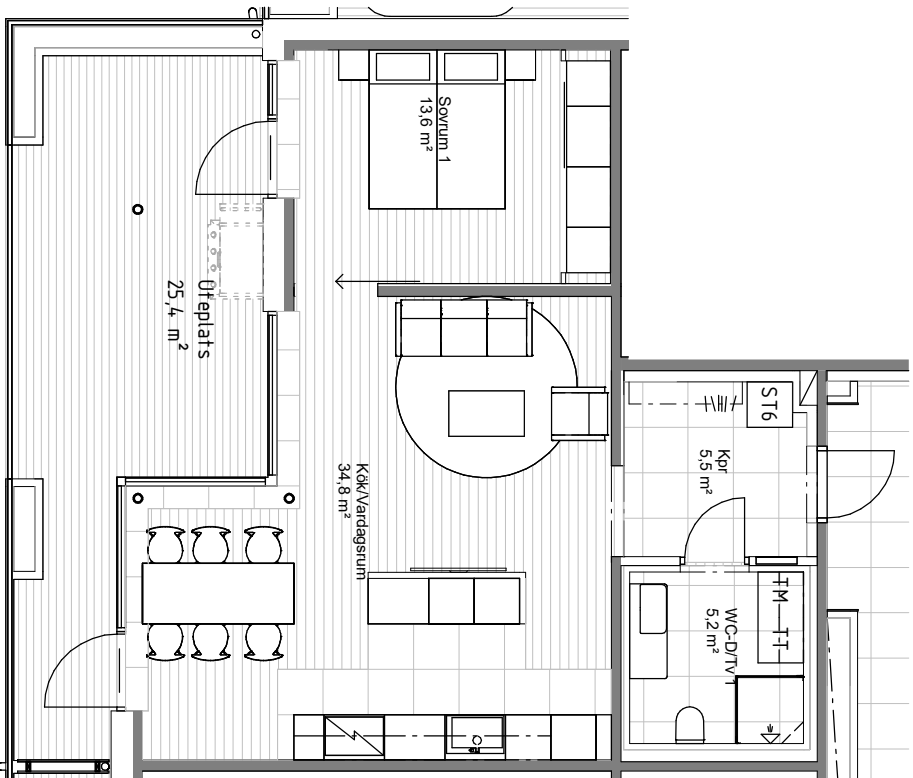

DM
21102 Externt Frd

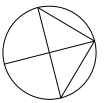

SKALA 1:100

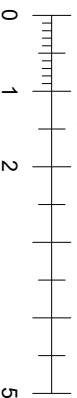

METER

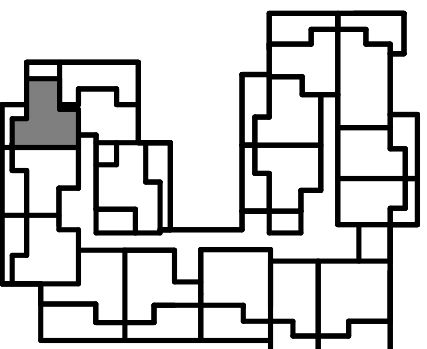

PROJEKTUTVECKLAREN RESERVERAR SIG FÖR
EVENTUELLA ÄNDRINGAR OCH TRYCKFEL

Kv 2, Råbylund, Lund

LGH NR:

21102

JOHAN SENNSTRÖM ARK SARMSA

2021-09-03, Rev.2023-12-05

3 Rok 81,6 Kvm + Uteplats 87 Kvm + 6,3 Kvm Externt frd

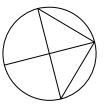
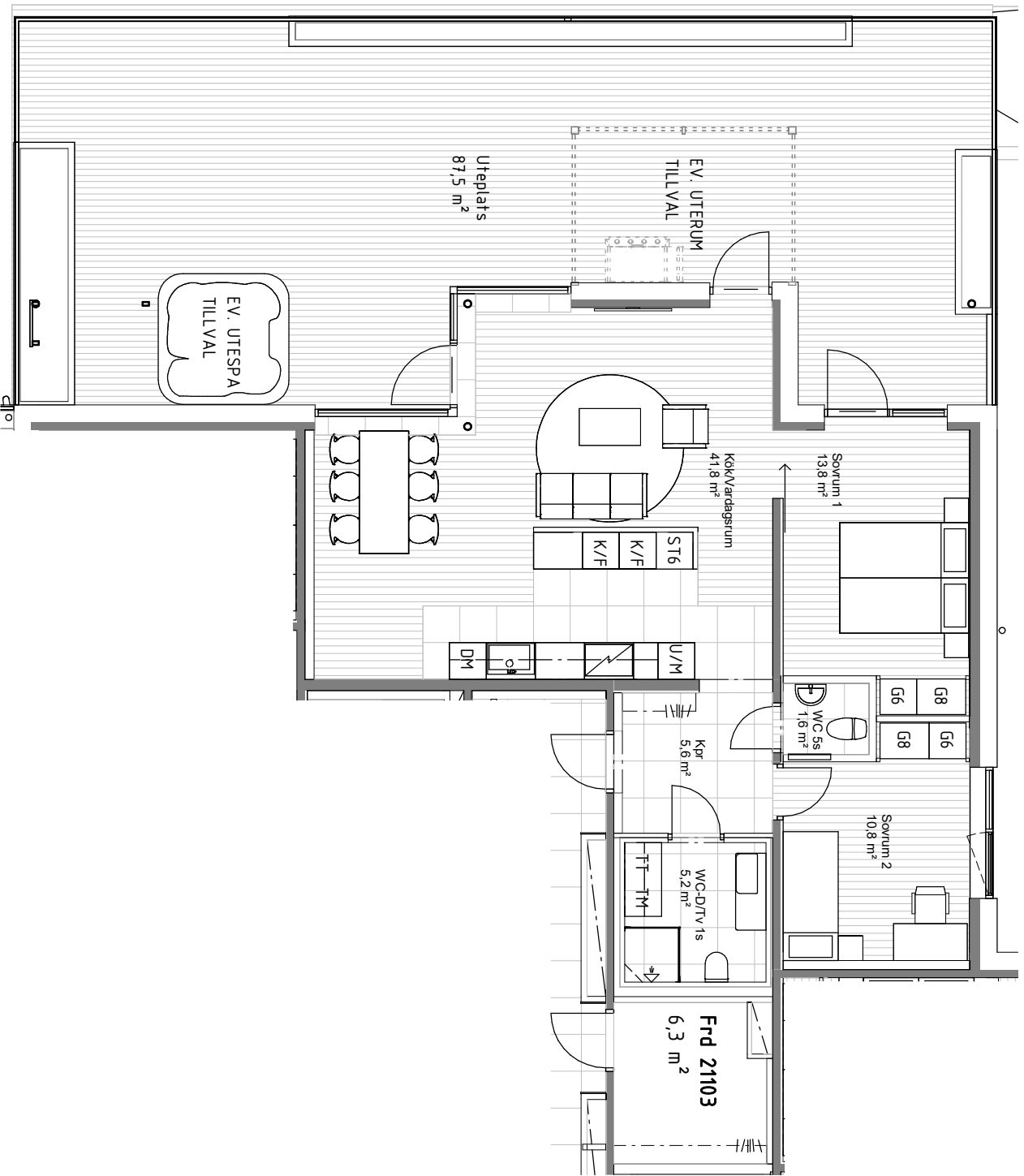

SKALA 1:100

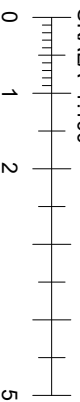

METER

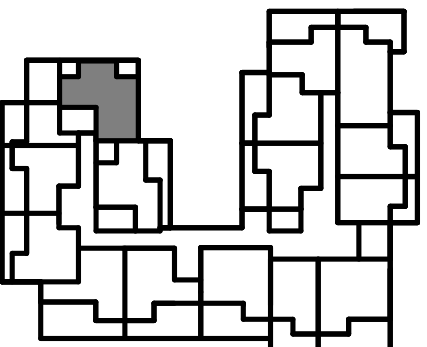

Kv 2, Råbylund, Lund

LGH NR:

21103

JOHAN SENNSTRÖM ARK SARMSA

2021-09-03, Rev.2023-12-19

PROJEKTUTVECKLAREN RESERVERAR SIG FÖR
EVENTUELLA ÄNDRINGAR OCH TRYCKFEL

3 RoK 73,5 Kvm + Uteplats 27 Kvm

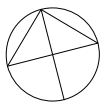
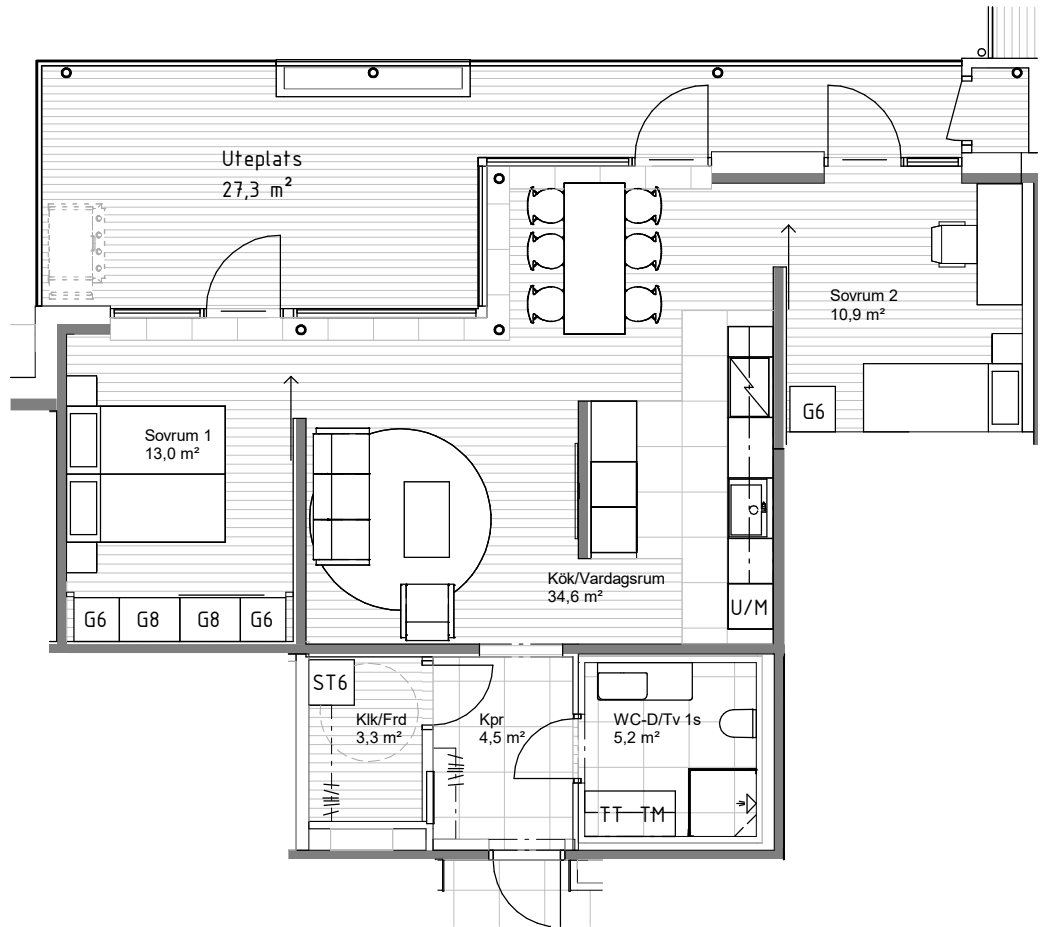

SKALA 1:100

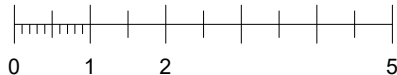

METER

PROJEKTUTVEKLAREN RESERVERAR SIG FÖR
EVENTUELLA ÄNDRINGAR OCH TRYCKFEL

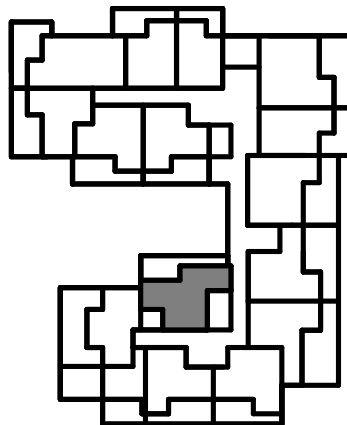

Kv 2, Råbylund, Lund

LGH NR:

21104

JOHAN SENNSTRÖM ARK SAR/MSA

2021-09-03, Rev.2023-12-05

2 RoK 67,3 Kvm + Uteplats 35 Kvm

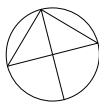
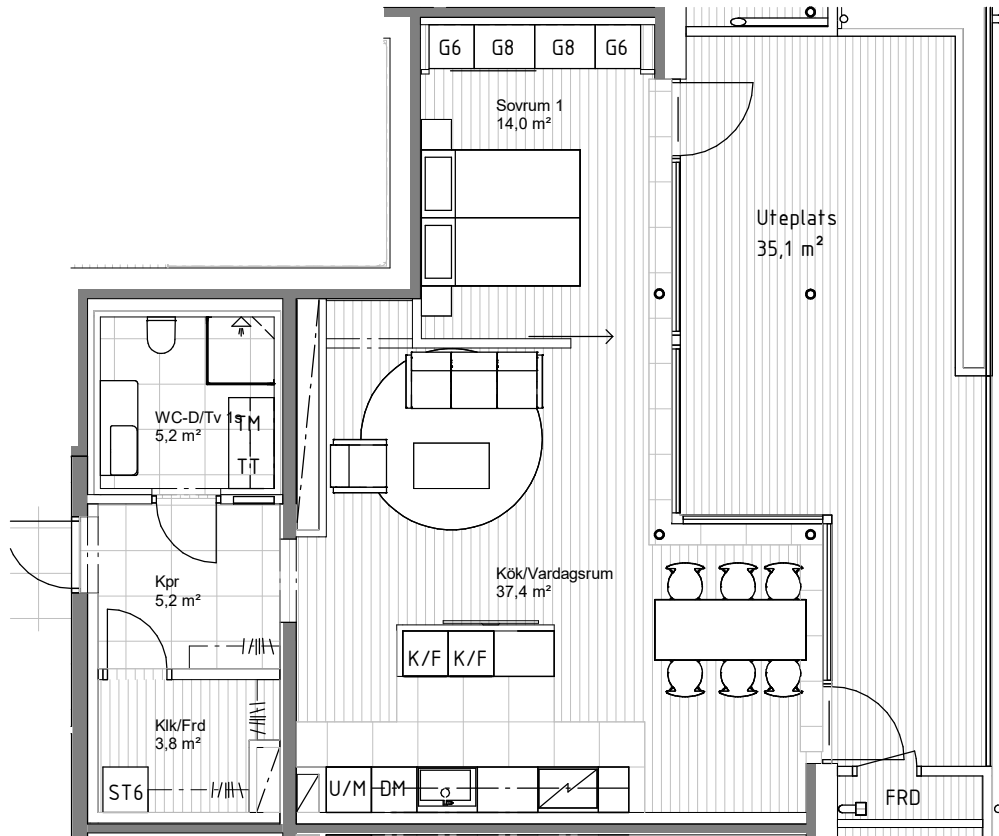

SKALA 1:100

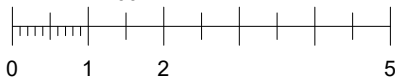

METER

PROJEKTUTVEKLAREN RESERVERAR SIG FÖR
EVENTUELLA ÄNDRINGAR OCH TRYCKFEL

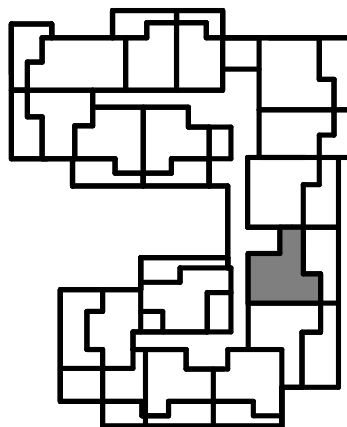

Kv 2, Råbylund, Lund

LGH NR:

21105

JOHAN SENNSTRÖM ARK SAR/MSA

2021-09-03, Rev.2023-12-05

2 RoK 67,4 Kvm + Uteplats 39 Kvm

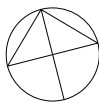
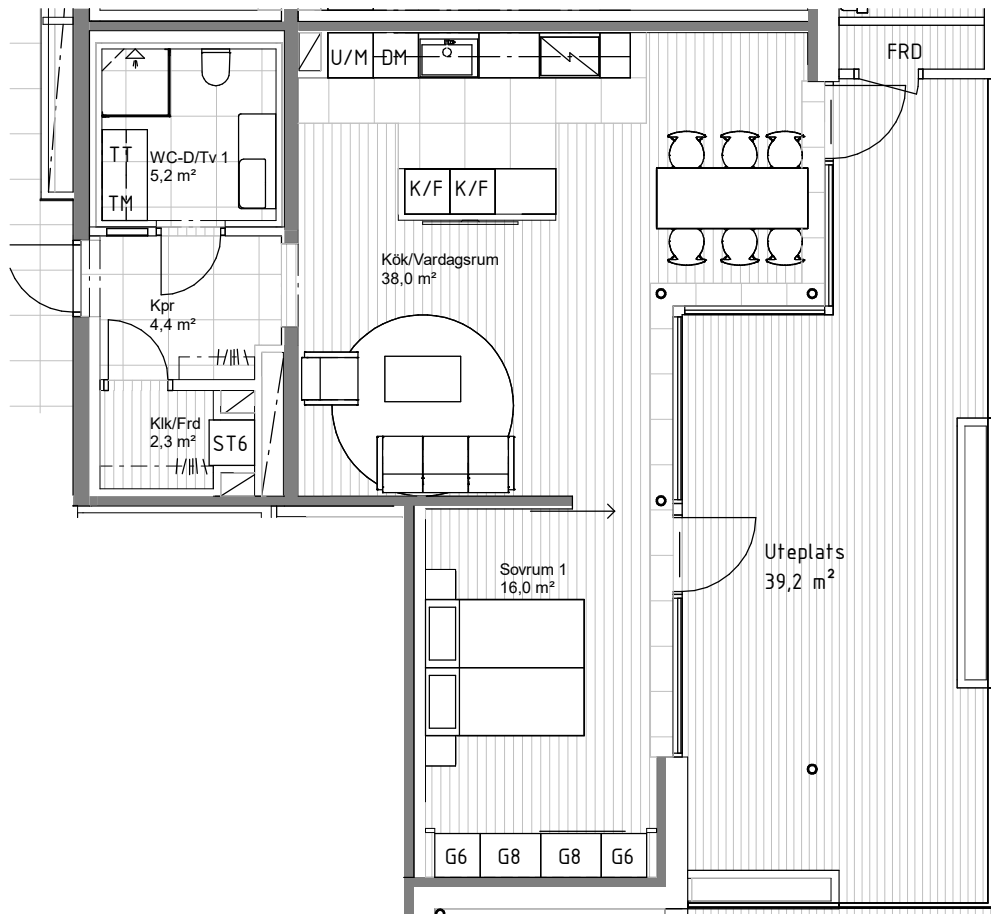

SKALA 1:100

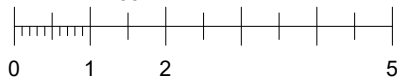

METER

PROJEKTUTVEKLAREN RESERVERAR SIG FÖR
EVENTUELLA ÄNDRINGAR OCH TRYCKFEL

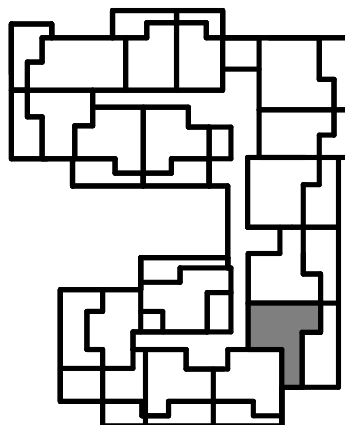

Kv 2, Råbylund, Lund

LGH NR:

21106

JOHAN SENNSTRÖM ARK SAR/MSA

2021-09-03, Rev.2023-12-05

2 RoK 64,3 Kvm + Uteplats 40 Kvm

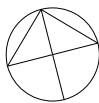
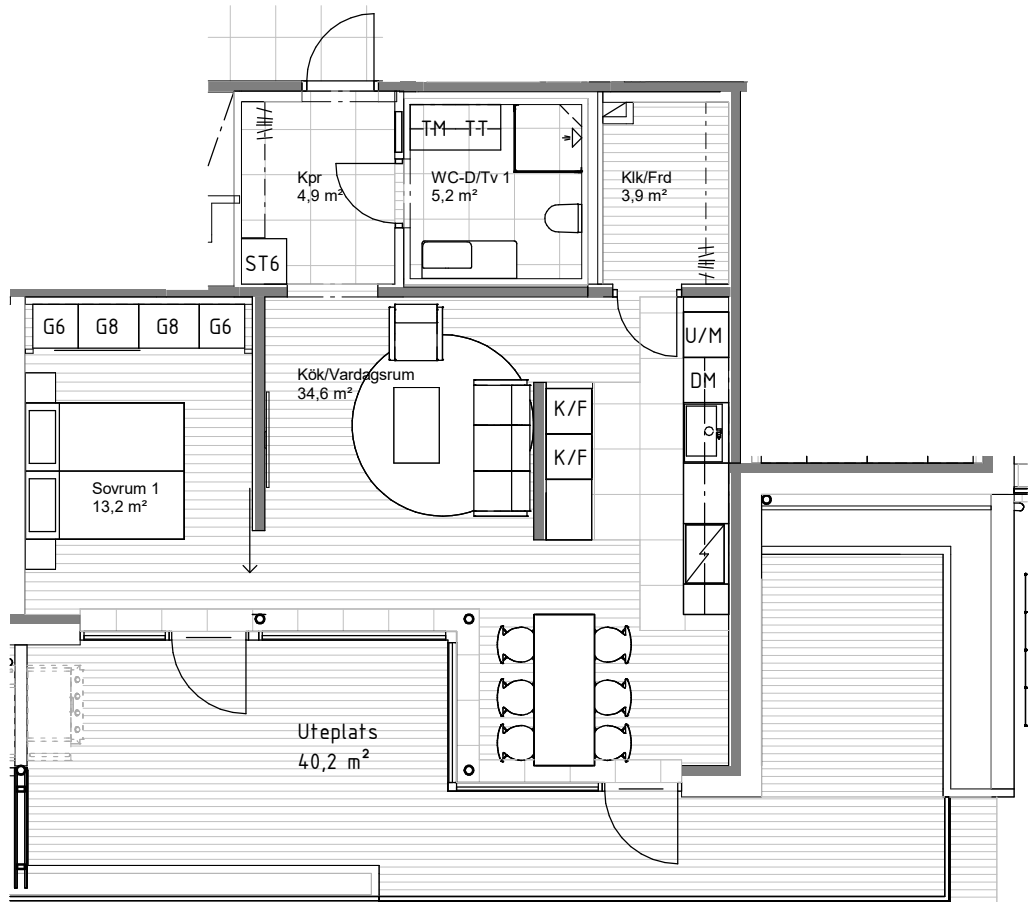

SKALA 1:100

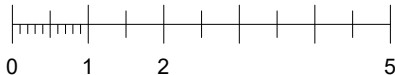

METER

PROJEKTUTVEKLAREN RESERVERAR SIG FÖR
EVENTUELLA ÄNDRINGAR OCH TRYCKFEL

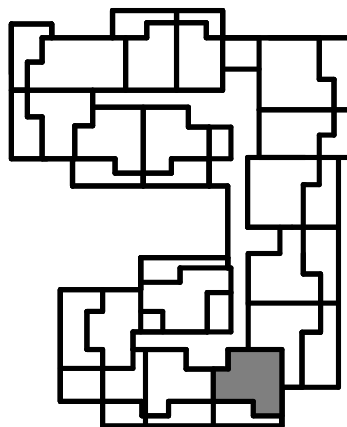

Kv 2, Råbylund, Lund

LGH NR:

21107

JOHAN SENNSTRÖM ARK SAR/MSA

2021-09-03, Rev.2023-12-05

3 RoK 90,1 Kvm + Uteplats 27 + 9 Kvm + 4,9 Kvm Externt förråd

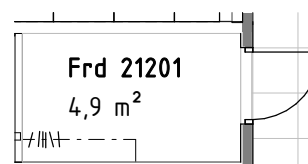
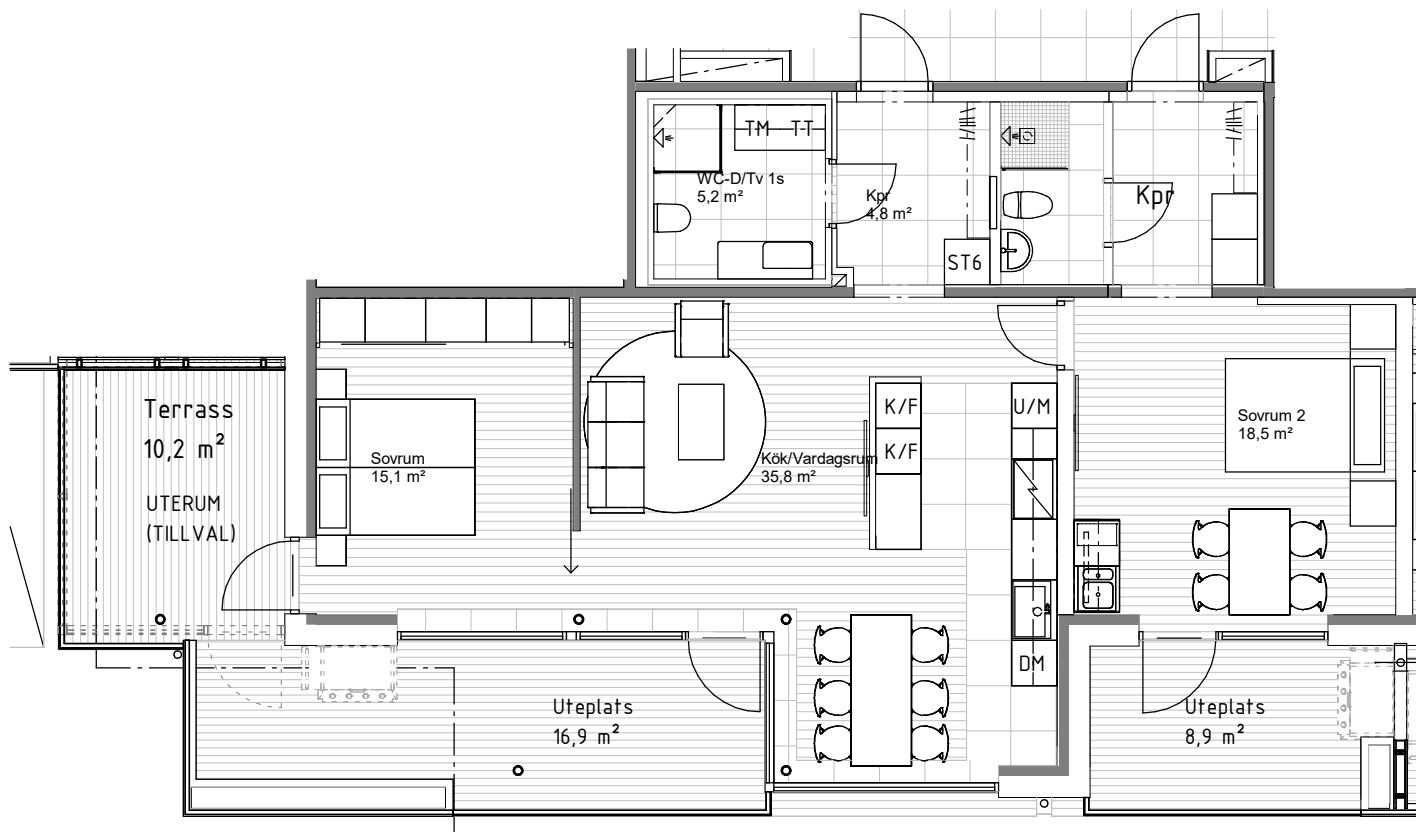

21201 Externt Förråd

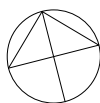

SKALA 1:100

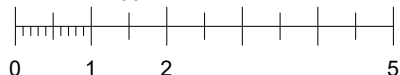

METER

PROJEKTUTVEKLAREN RESERVERAR SIG FÖR
EVENTUELLA ÄNDRINGAR OCH TRYCKFEL

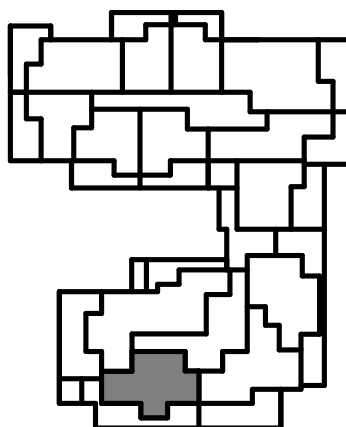

Kv 2, Råbylund, Lund

LGH NR:

21201

JOHAN SENNSTRÖM ARK SAR/MSA

2021-09-03, Rev.2023-12-05

3 RoK 80,6 Kvm + Uteplats 56 Kvm + 3,8 Kvm ext. frd

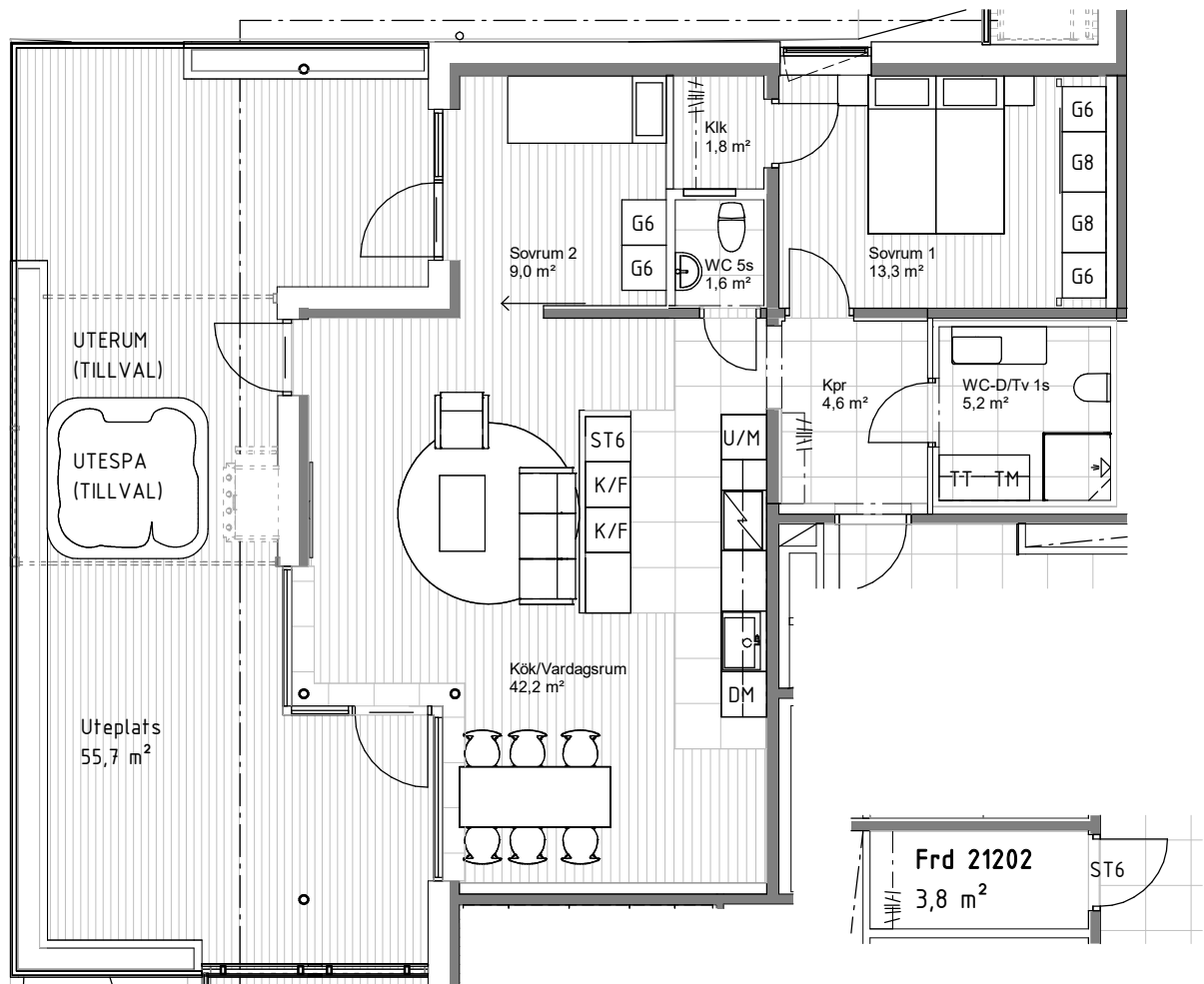

21202 Externt Förråd

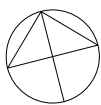

SKALA 1:100

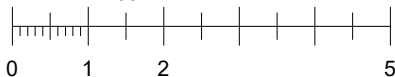

METER

PROJEKTUTVEKLAREN RESERVERAR SIG FÖR
EVENTUELLA ÄNDRINGAR OCH TRYCKFEL

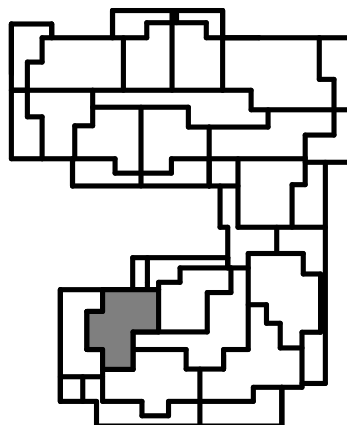

Kv 2, Råbylund, Lund

LGH NR:

21202

JOHAN SENNSTRÖM ARK SAR/MSA

2021-09-03, Rev.2023-12-05

2 Rok 62,6 Kv_m + Uteplats 23 Kv_m

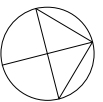
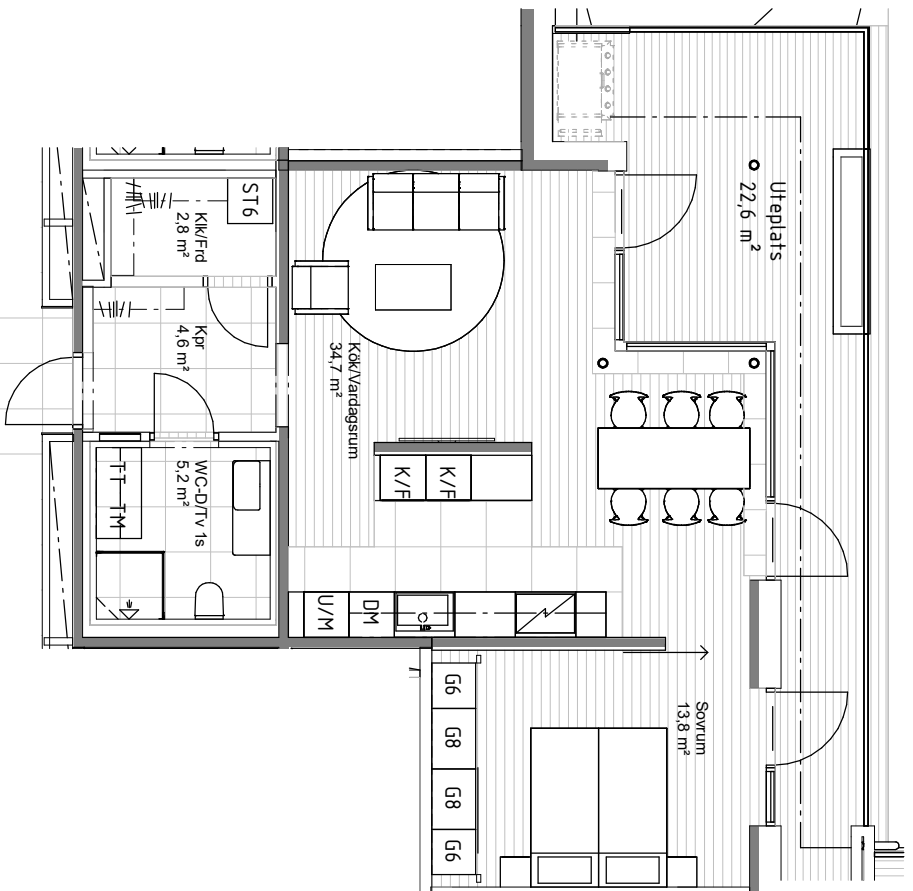

SKALA 1:100

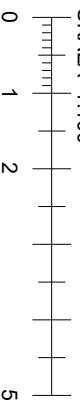

METER

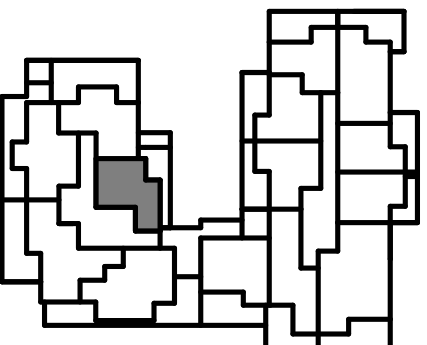

Kv 2, Råbylund, Lund

LGH NR:

21203

JOHAN SENNSTRÖM ARK SARMISA

PROJEKTUTVECKLAREN RESERVERAR SIG FÖR
EVENTUELLA ÄNDRINGAR OCH TRYCKFEL

2021-09-03, Rev.2023-12-05

3 RoK 71,7 Kvm + Uteplats 31 Kvm + 14 Kvm

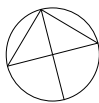
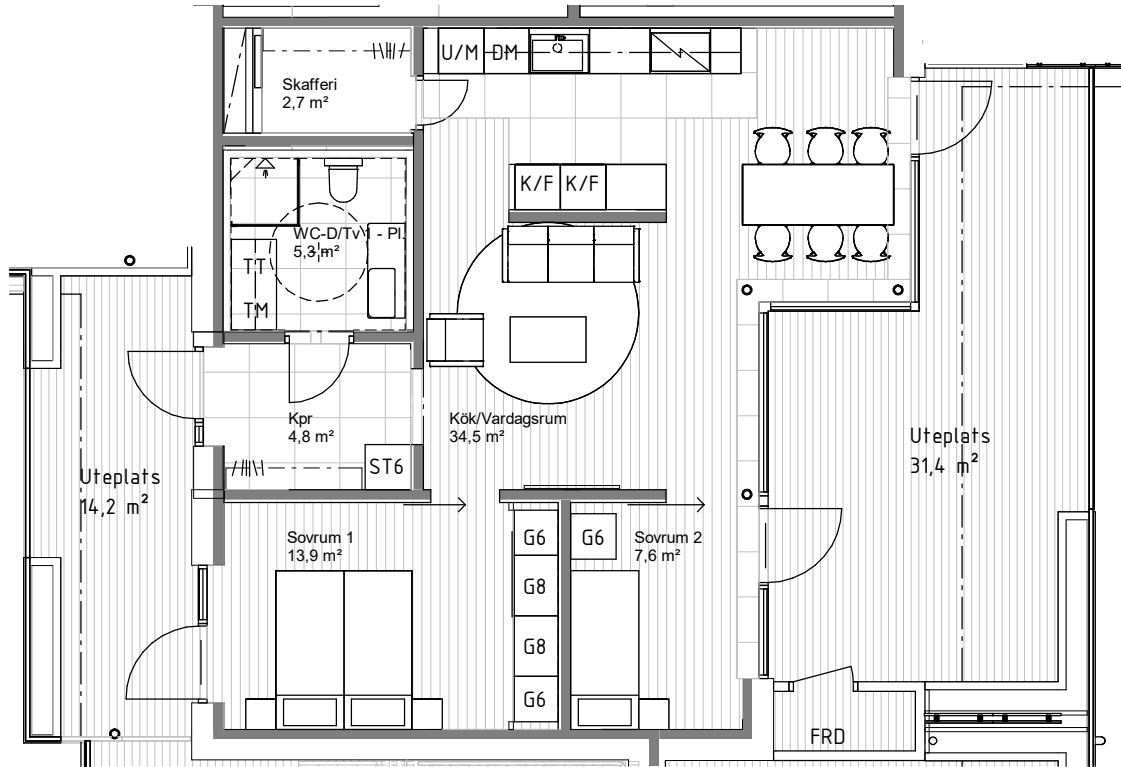

SKALA 1:100

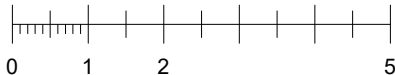

METER

PROJEKTUTVEKLAREN RESERVERAR SIG FÖR
EVENTUELLA ÄNDRINGAR OCH TRYCKFEL

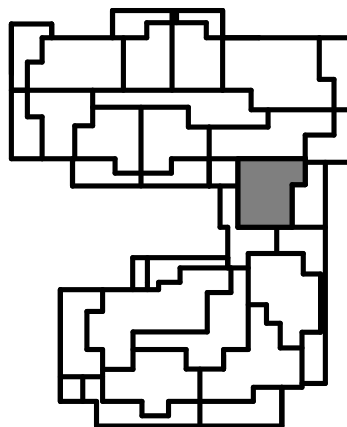

Kv 2, Råbylund, Lund

LGH NR:

21204

JOHAN SENNSTRÖM ARK SAR/MSA

2021-09-03, Rev.2023-12-05

3 RoK 82,1 Kvm + Uteplats 34 Kvm

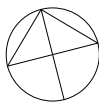
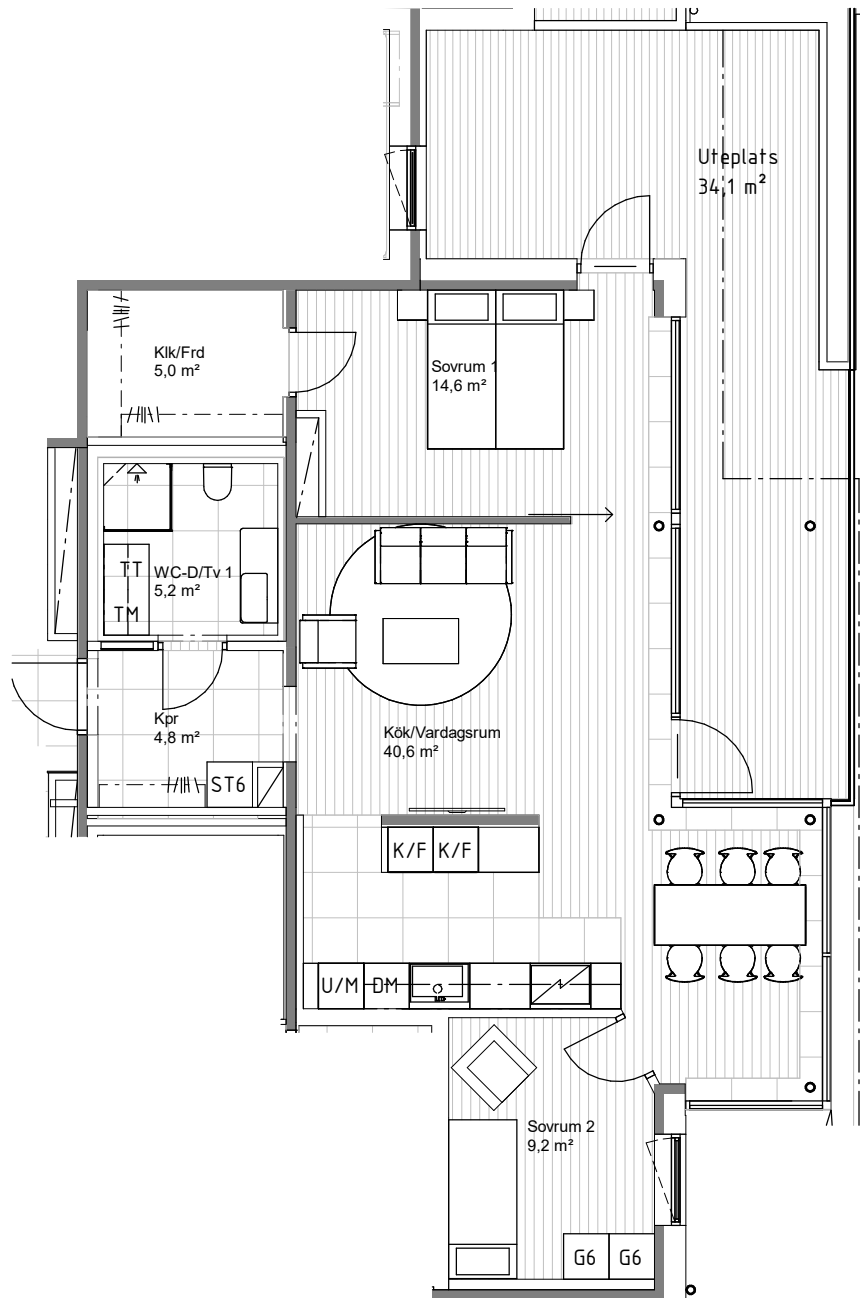

SKALA 1:100

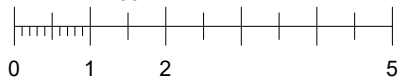

METER

PROJEKTUTVEKLAREN RESERVERAR SIG FÖR
EVENTUELLA ÄNDRINGAR OCH TRYCKFEL

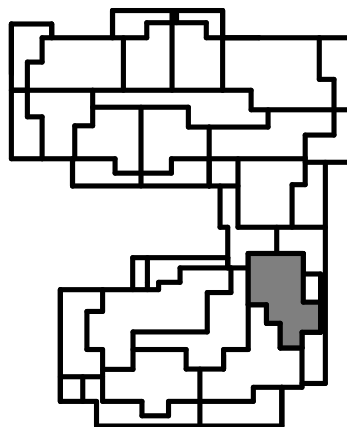

Kv 2, Råbylund, Lund

LGH NR:

21205

JOHAN SENNSTRÖM ARK SAR/MSA

2021-09-03, Rev.2023-12-05

4 RoK 97,5 Kvm + Uteplats 32 Kvm

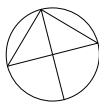
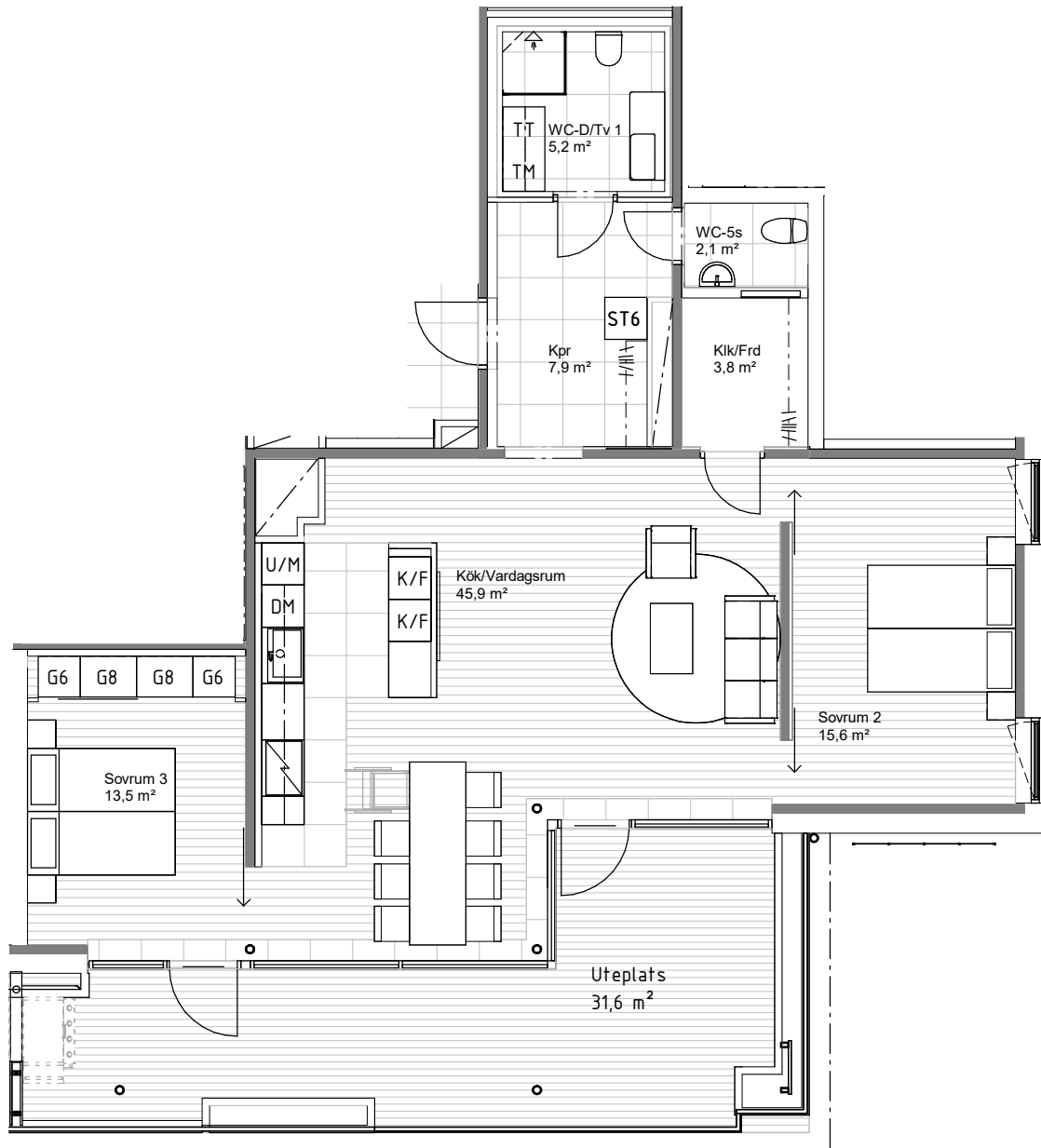

SKALA 1:100

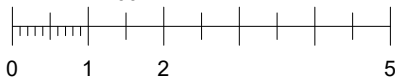

METER

PROJEKTUTVEKLAREN RESERVERAR SIG FÖR
EVENTUELLA ÄNDRINGAR OCH TRYCKFEL

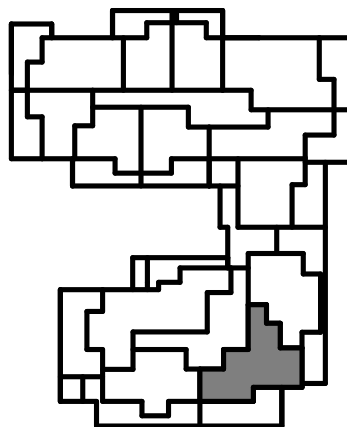

Kv 2, Råbylund, Lund

LGH NR:

21206

JOHAN SENNSTRÖM ARK SAR/MSA

2021-09-03, Rev.2023-12-05

5 RoK 130,1 Kvm + Uteplats 59 + 14 Kvm

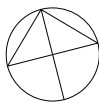
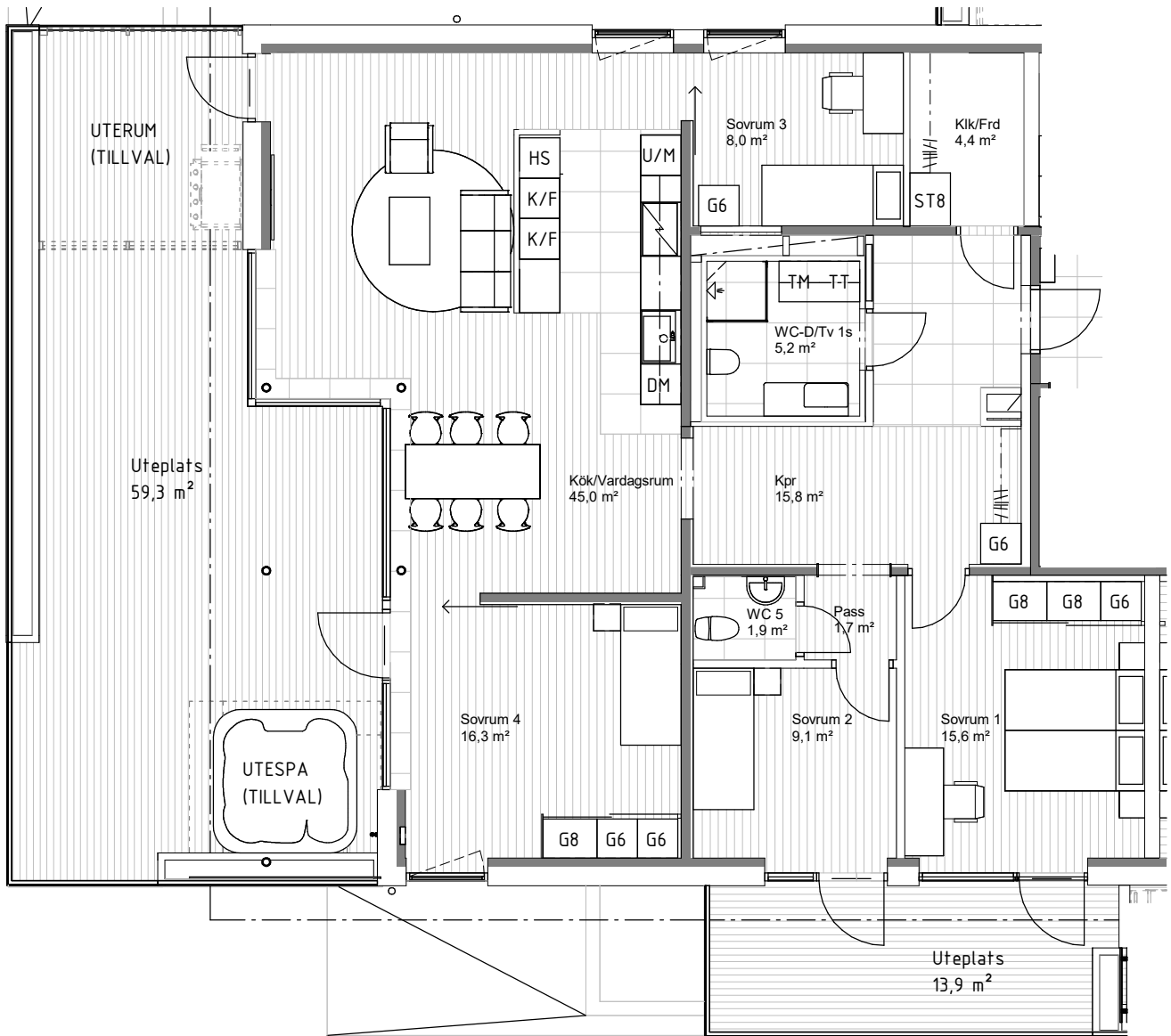

SKALA 1:100

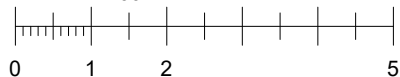

METER

PROJEKTUTVEKLAREN RESERVERAR SIG FÖR
EVENTUELLA ÄNDRINGAR OCH TRYCKFEL

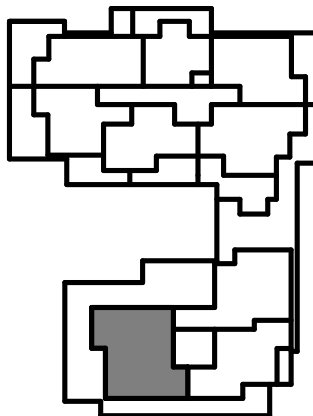

Kv 2, Råbylund, Lund

LGH NR:

21301

JOHAN SENNSTRÖM ARK SAR/MSA

2021-09-03, Rev.2023-12-05

5 RoK 112,5 Kvm + Uteplats 61 Kvm + 7,5 Kvm ext. Frd

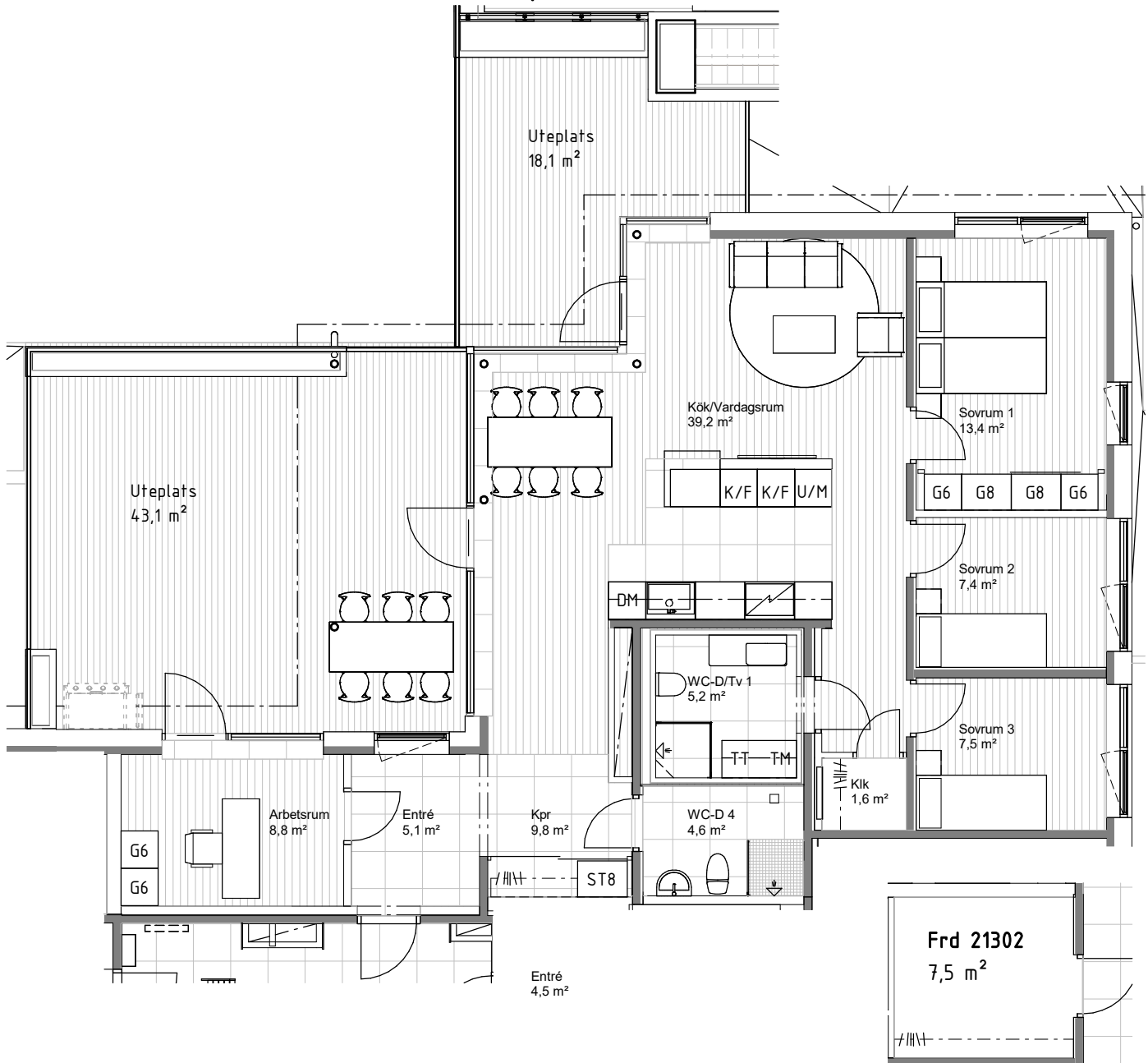

21302 Externt Frd

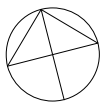

SKALA 1:100

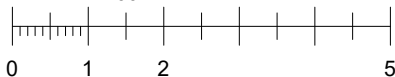

METER

PROJEKTUTVEKLAREN RESERVERAR SIG FÖR
EVENTUELLA ÄNDRINGAR OCH TRYCKFEL

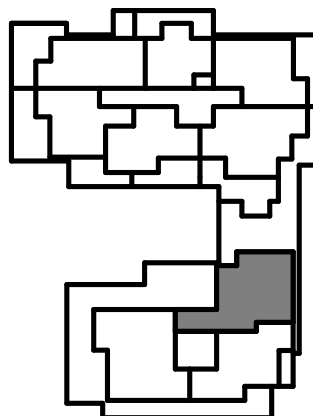

Kv 2, Råbylund, Lund

LGH NR:

21302

JOHAN SENNSTRÖM ARK SAR/MSA

2021-09-03, Rev.2023-12-05

4 RoK 93,5 Kvm + Uteplats 33 Kvm + 3,5 Kvm externt Frd

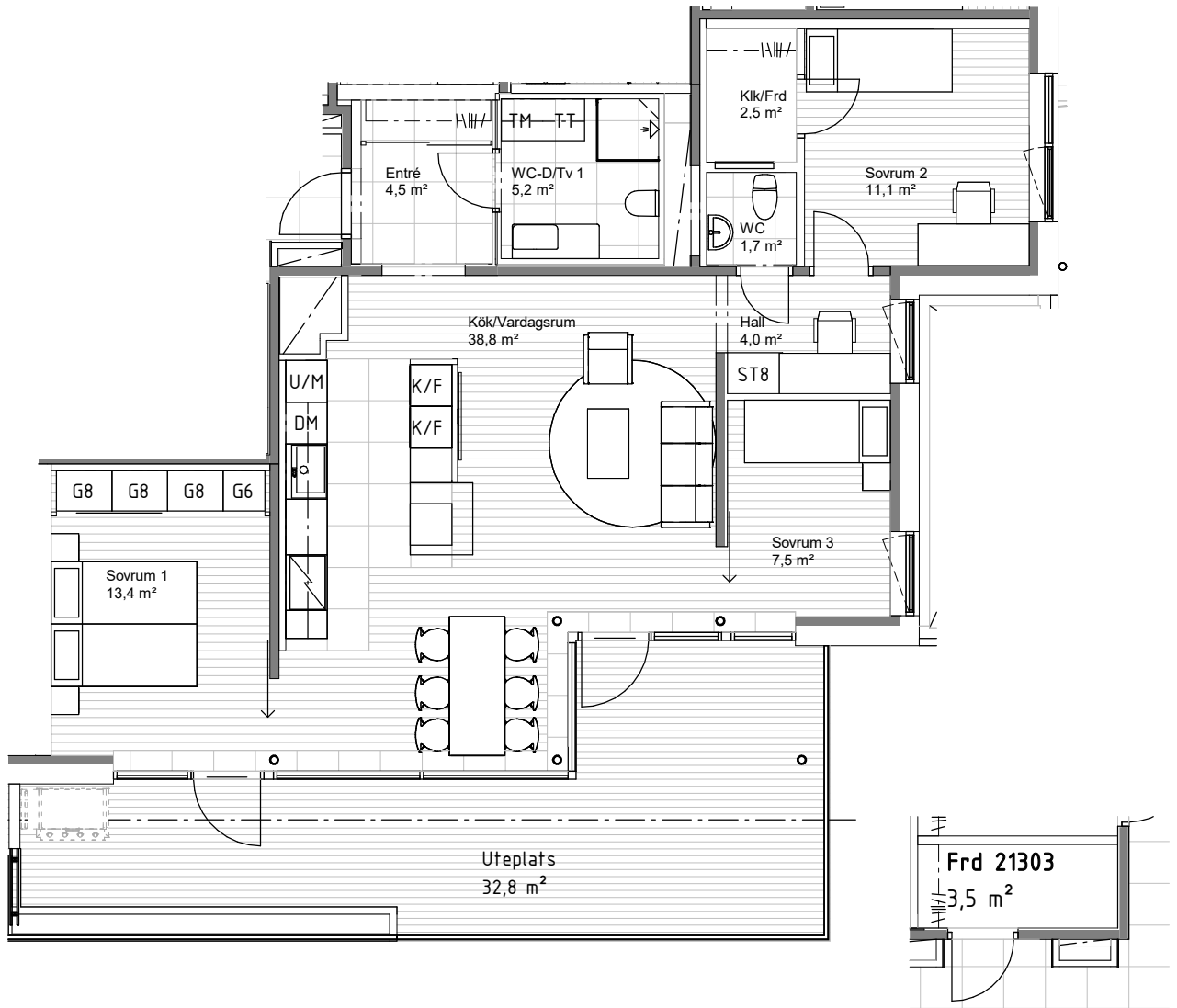

21303 Externt Frd

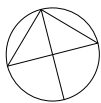

SKALA 1:100

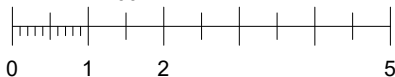

METER

PROJEKTUTVEKLAREN RESERVERAR SIG FÖR
EVENTUELLA ÄNDRINGAR OCH TRYCKFEL

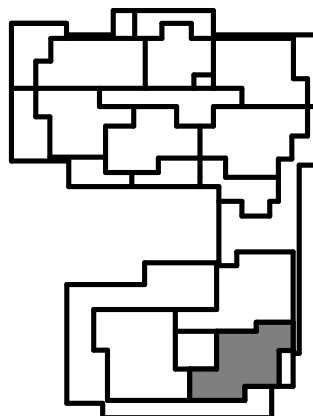

Kv 2, Råbylund, Lund

LGH NR:

21303

JOHAN SENNSTRÖM ARK SAR/MSA

2021-09-03, Rev.2023-12-05